

INTERNATIONAL
RECOMMENDATION

OIML R 76-1

Edition 2006 (E)

Non-automatic weighing instruments

Part 1: Metrological and technical requirements - Tests

Instruments de pesage à fonctionnement non automatique

Partie 1: Exigences métrologiques et techniques - Essais



CONTENTS

Foreword.....	4
T Terminology	5
T.1 General definitions.....	5
T.2 Construction of an instrument.....	7
T.3 Metrological characteristics of an instrument.....	13
T.4 Metrological properties of an instrument.....	15
T.5 Indications and errors.....	15
T.6 Influences and reference conditions.....	20
T.7 Performance test	20
T.8 Index of terms defined.....	21
T.9 Abbreviations and symbols.....	23
1 Scope	25
2 Principles of the Recommendation	25
2.1 Units of measurement.....	25
2.2 Principles of the metrological requirements.....	25
2.3 Principles of the technical requirements.....	25
2.4 Application of requirements	26
2.5 Terminology	26
3 Metrological requirements.....	26
3.1 Principles of classification.....	26
3.2 Classification of instruments.....	27
3.3 Additional requirements for multi-interval instruments.....	27
3.4 Auxiliary indicating devices.....	28
3.5 Maximum permissible errors.....	30
3.6 Permissible differences between results.....	31
3.7 Test standards.....	32
3.8 Discrimination.....	32
3.9 Variations due to influence quantities and time.....	33
3.10 Type evaluation tests and examinations.....	36
4 Technical requirements for a self- or semi-self-indicating instrument.....	41
4.1 General construction requirements.....	41
4.2 Indication of weighing results.....	43
4.3 Analog indicating devices.....	45
4.4 Digital indicating devices.....	46
4.5 Zero-setting and zero-tracking devices.....	47
4.6 Tare devices.....	49
4.7 Preset tare devices.....	53
4.8 Locking positions.....	53
4.9 Auxiliary verification devices (removable or fixed).....	54
4.10 Selection of weighing ranges on a multiple range instrument.....	54
4.11 Devices for selection (or switching) between various load receptors and/or load transmitting devices and various load measuring devices.....	54
4.12 "Plus and minus" comparator instruments.....	55
4.13 Instruments for direct sales to the public.....	55
4.14 Additional requirements for price-computing instruments for direct sales to the public.....	57
4.15 Instruments similar to those normally used for direct sales to the public.....	59
4.16 Price-labeling instruments.....	59
4.17 Mechanical counting instruments with unit-weight receptor.....	59
4.18 Additional technical requirements for mobile instruments.....	59
4.19 Portable instruments for weighing road vehicles.....	60
4.20 Modes of operation.....	61
5 Technical requirements for electronic instruments.....	61
5.1 General requirements.....	61
5.2 Acting upon significant faults.....	62
5.3 Functional requirements.....	62
5.4 Performance and span stability tests.....	63
5.5 Additional requirements for software-controlled electronic devices.....	64
6 Technical requirements for non-self-indicating instruments.....	69

6.1	Minimum sensitivity	70
6.2	Acceptable solutions for indicating devices	70
6.3	Conditions of construction	71
6.4	Simple equal arm beam	72
6.5	Simple 1/10 ratio beam	72
6.6	Simple sliding poise instruments (steelyards)	73
6.7	Roberval and Béranger instruments	74
6.8	Instruments with ratio platforms	74
6.9	Instruments with a load-measuring device having accessible sliding poises (of the steelyard type)	75
7	Marking of instruments and modules	76
7.1	Descriptive markings	76
7.2	Verification marks	79
8	Metrological controls	80
8.1	Liability to metrological controls	80
8.2	Type approval	80
8.3	Initial verification	82
8.4	Subsequent metrological control	83
Annex A	Testing procedures for non-automatic weighing instruments	85
A.1	Administrative examination	85
A.2	Compare construction with documentation	85
A.3	Initial examination	85
A.4	Performance tests	85
A.5	Influence factors	94
A.6	Endurance test	97
Annex B	Additional tests for electronic instruments	100
B.1	General requirements for electronic instruments under test	100
B.2	Damp heat, steady state	100
B.3	Performance tests for disturbances	101
B.4	Span stability test	106
Annex C	Testing and certification of indicators and analog data processing devices as modules of non-automatic weighing instruments	108
C.1	Applicable requirements	108
C.2	General principles of testing	109
C.3	Tests	112
C.4	OIML Certificates	116
Annex D	Testing and certification of digital data processing devices, terminals and digital displays as modules of non-automatic weighing instruments	118
D.1	Applicable requirements	118
D.2	General principles of testing	119
D.3	Tests	119
D.4	OIML Certificates	120
Annex E	Testing and certification of weighing modules as modules of non-automatic weighing instruments	122
E.1	Applicable requirements	122
E.2	General principles of testing	123
E.3	Tests	123
E.4	OIML Certificates	124
Annex F	Compatibility checking of modules of non-automatic weighing instruments	126
F.1	Weighing instrument	126
F.2	Separately tested load cells	127
F.3	Separately tested indicators and analog data processing devices	129
F.4	Compatibility checks for modules with analog output	130
F.5	Compatibility checks for modules with digital output	132
F.6	Examples of compatibility checks for modules with analog output	132
Annex G	Additional examinations and tests for software-controlled digital devices and instruments	137
G.1	Devices and instruments with embedded software	137
G.2	Personal computers and other devices with programmable or loadable software	137
G.3	Data storage devices	138
G.4	Test Report Format	139
	Bibliography	140

Foreword

The International Organization of Legal Metrology (OIML) is a worldwide, intergovernmental organization whose primary aim is to harmonize the regulations and metrological controls applied by the national metrological services, or related organizations, of its Member States. The main categories of OIML publications are:

- **International Recommendations (OIML R)**, which are model regulations that establish the metrological characteristics required of certain measuring instruments and which specify methods and equipment for checking their conformity. OIML Member States shall implement these Recommendations to the greatest possible extent;
- **International Documents (OIML D)**, which are informative in nature and which are intended to harmonize and improve work in the field of legal metrology;
- **International Guides (OIML G)**, which are also informative in nature and which are intended to give guidelines for the application of certain requirements to legal metrology; and
- **International Basic Publications (OIML B)**, which define the operating rules of the various OIML structures and systems.

OIML Draft Recommendations, Documents and Guides are developed by Technical Committees or Subcommittees which comprise representatives from the Member States. Certain international and regional institutions also participate on a consultation basis. Cooperative agreements have been established between the OIML and certain institutions, such as ISO and the IEC, with the objective of avoiding contradictory requirements. Consequently, manufacturers and users of measuring instruments, test laboratories, etc. may simultaneously apply OIML publications and those of other institutions.

International Recommendations, Documents, Guides and Basic Publications are published in English (E) and translated into French (F) and are subject to periodic revision.

Additionally, the OIML publishes or participates in the publication of **Vocabularies (OIML V)** and periodically commissions legal metrology experts to write **Expert Reports (OIML E)**. Expert Reports are intended to provide information and advice, and are written solely from the viewpoint of their author, without the involvement of a Technical Committee or Subcommittee, nor that of the International Committee of Legal Metrology. Thus, they do not necessarily represent the views of the OIML.

This publication - reference OIML R 76-1, Edition 2006 - was developed by Technical Subcommittee TC 9/SC 1 *Non-automatic weighing instruments*. It was approved for final publication by the International Committee of Legal Metrology in 2006 and will be submitted to the International Conference of Legal Metrology in 2008 for formal sanction. It supersedes the previous edition of R 76-1 (1992).

OIML Publications may be downloaded from the OIML web site in the form of PDF files. Additional information on OIML Publications may be obtained from the Organization's headquarters:

Bureau International de Métrologie Légale
11, rue Turgot - 75009 Paris - France
Telephone: 33 (0)1 48 78 12 82
Fax: 33 (0)1 42 82 17 27
E-mail: biml@oiml.org
Internet: www.oiml.org

TERMINOLOGY

(terms, definitions and references)

The terminology used in this Recommendation conforms to the “International Vocabulary of Basic and General Terms in Metrology” (VIM) [1], the “International Vocabulary of Terms in Legal Metrology” (VIML) [2], the “OIML Certificate System for Measuring Instruments” [3] and other relevant OIML publications. In addition, for the purposes of this Recommendation, the following definitions apply. An index of all the terms, definitions and references defined below can be found under T.8.

T.1 General definitions

T.1.1 Weighing instrument

Measuring instrument that serves to determine the mass of a body by using the action of gravity on this body.

Note: In this Recommendation “mass” (or “weight value”) is preferably used in the sense of “conventional mass” or “conventional value of the result of weighing in air” according to R 111 and D 28, whereas “weight” is preferably used for an embodiment (i.e. material measure) of mass that is regulated in regard to its physical and metrological characteristics.

The instrument may also be used to determine other quantities, magnitudes, parameters or characteristics related to the determined mass.

According to its method of operation, a weighing instrument is classified as an automatic weighing instrument or a non-automatic weighing instrument.

T.1.2 Non-automatic weighing instrument

Instrument that requires the intervention of an operator during the weighing process to decide that the weighing result is acceptable.

Note 1: Deciding that the weighing result is acceptable includes any intelligent action by the operator that affects the result, such as taking an action when an indication is stable or adjusting the mass of the weighed load, and to make a decision regarding the acceptance of each weighing result on observing the indication or releasing a print out. A non-automatic weighing process allows the operator to take an action (i.e. adjust the load, adjust the unit price, determine that the load is acceptable, etc.) which influences the weighing result in the case where the weighing result is not acceptable.

Note 2: In case of doubt as to whether an instrument is a non-automatic weighing instrument or an automatic weighing instrument, the definitions for automatic weighing instruments given in OIML Recommendations R 50, R 51, R 61, R 106, R 107 and R 134 have higher priority than the criteria of *Note 1* above.

A non-automatic weighing instrument may be:

- graduated or non-graduated; or
- self-indicating, semi-self-indicating or non-self-indicating.

Note: In this Recommendation a non-automatic weighing instrument is called an “instrument”.

T.1.2.1 Graduated instrument

Instrument allowing the direct reading of the complete or partial weighing result.

T.1.2.2 Non-graduated instrument

Instrument not fitted with a scale numbered in units of mass.

T.1.2.3 Self-indicating instrument

Instrument in which the position of equilibrium is obtained without the intervention of an operator.

T.1.2.4 Semi-self-indicating instrument

Instrument with a self-indicating weighing range, in which the operator intervenes to alter the limits of this range.

T.1.2.5 Non-self-indicating instrument

Instrument in which the position of equilibrium is obtained entirely by the operator.

T.1.2.6 Electronic instrument

Instrument equipped with electronic devices.

T.1.2.7 Instrument with price scales

Instrument that indicates the price to pay by means of price charts or scales related to a range of unit prices.

T.1.2.8 Price-computing instrument

Instrument that calculates the price to pay on the basis of the indicated weight value and the unit price.

T.1.2.9 Price-labeling instrument

Price-computing instrument that prints the weight value, unit price and price to pay for prepackages.

T.1.2.10 Self-service instrument

Instrument that is intended to be operated by the customer.

T.1.2.11 Mobile instrument

Non-automatic weighing instrument mounted on or incorporated into a vehicle.

Note 1: A vehicle-mounted instrument is a complete weighing instrument which is firmly mounted on a vehicle, and which is designed for that special purpose.

Example: Postal scale mounted on a vehicle (mobile post office).

Note 2: A vehicle-incorporated instrument uses parts of the vehicle for the weighing instrument.

Examples: Garbage weighers, patient lifters, pallet lifters, fork lifters, wheel chair weighers.

T.1.2.12 Portable instrument for weighing road vehicles

Non-automatic weighing instrument having a load receptor, in one or several parts, which determines the total mass of road vehicles, and which is designed to be moved to other locations.

Examples: Portable weighbridge, group of associated non-automatic axle (or wheel) load weighers.

Note: This Recommendation covers only weighbridges and groups of associated non-automatic axle (or wheel) load weighers that determine simultaneously the total mass of a road vehicle with all axles (or wheels) being simultaneously supported by appropriate parts of a load receptor.

T.1.2.13 Grading instrument

Instrument which assigns a weighing result to a predetermined range of mass to determine a tariff or toll.

Examples: Postal scales, garbage weighers.

T.1.3 Indications of an instrument

Value of a quantity provided by a measuring instrument.

Note: “Indication”, “indicate” or “indicating” includes both displaying and/or printing.

T.1.3.1 Primary indications

Indications, signals and symbols that are subject to requirements of this Recommendation.

T.1.3.2 Secondary indications

Indications, signals and symbols that are not primary indications.

T.2 Construction of an instrument

In this Recommendation the term “device” is used for any means by which a specific function is performed, irrespective of the physical realization, e.g. by a mechanism or a key initiating an operation. The device may be a small part or a major portion of an instrument.

T.2.1 Main devices

T.2.1.1 Load receptor

Part of the instrument intended to receive the load.

T.2.1.2 Load-transmitting device

Part of the instrument for transmitting the force produced by the load acting on the load receptor to the load-measuring device.

T.2.1.3 Load-measuring device

Part of the instrument for measuring the mass of the load by means of an equilibrium device for balancing the force coming from the load transmitting device, and an indicating or printing device.

T.2.2 Module

Identifiable part of an instrument that performs a specific function or functions, and that can be separately evaluated according to specific metrological and technical performance requirements in the relevant Recommendation. The modules of a weighing instrument are subject to specified partial error limits.

Note: Typical modules of a weighing instrument are: load cell, indicator, analog or digital data processing device, weighing module, terminal, primary display.

Independent OIML Certificates according to R 76 can be issued for the modules mentioned in T.2.2.2-T.2.2.7.

Figure 1
Definition of typical modules according to T.2.2 and 3.10.2
(other combinations are possible)

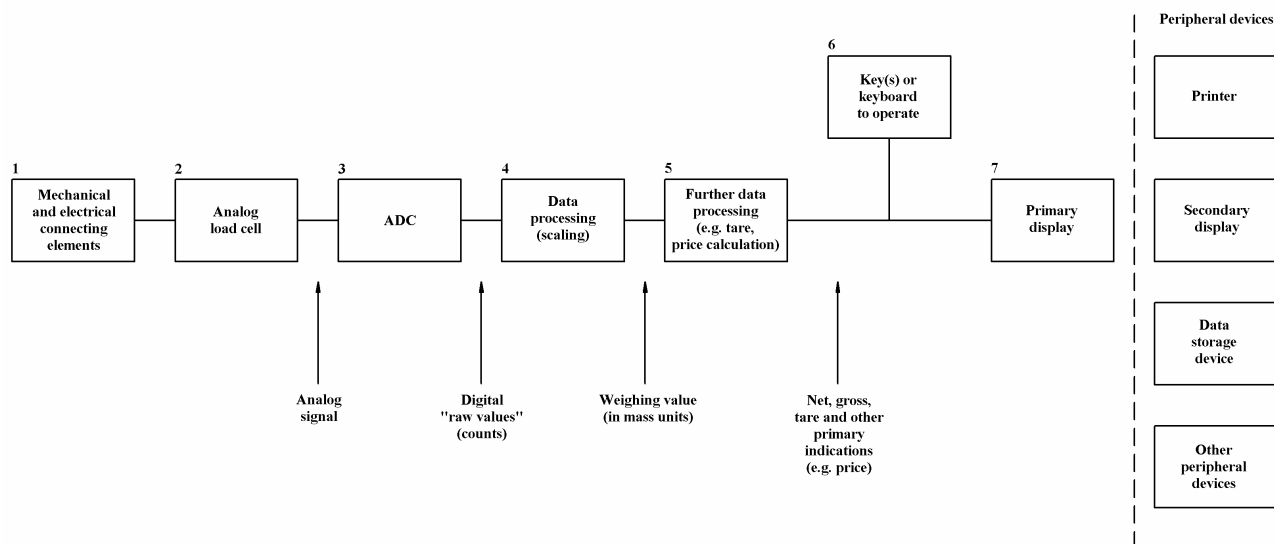

Analog load cell	(T.2.2.1)	2
Digital load cell	(T.2.2.1)	2 + 3 + (4)*
Indicator	(T.2.2.2)	(3) + 4 + (5) + (6) + 7
Analog data processing device	(T.2.2.3)	3 + 4 + (5) + (6)
Digital data processing device	(T.2.2.4)	(4) + 5 + (6)
Terminal	(T.2.2.5)	(5) + 6 + 7
Primary display	(T.2.2.6)	7
Weighing module	(T.2.2.7)	1 + 2 + 3 + 4 + (5) + (6)

* Numbers in brackets indicate options

T.2.2.1 Load cell [OIML R 60: 2000, 2.1.2]

Force transducer which, after taking into account the effects of the acceleration of gravity and air buoyancy at the location of its use, measures mass by converting the measured quantity (mass) into another measured quantity (output).

Note: Load cells equipped with electronics including amplifier, analog-to-digital converter (ADC), and data processing device (optionally) are called digital load cells (see Figure 1).

T.2.2.2 Indicator

Electronic device of an instrument that may perform the analog-to-digital conversion of the output signal of the load cell, and which further processes the data, and displays the weighing result in units of mass.

T.2.2.3 Analog data processing device

Electronic device of an instrument that performs the analog-to-digital conversion of the output signal of the load cell, further processes the data, and supplies the weighing result in a digital format via a digital interface without displaying it. It may optionally have one or more keys (or mouse, touch-screen, etc.) to operate the instrument.

T.2.2.4 Digital data processing device

Electronic device of an instrument that further processes the data, and supplies the weighing result in a digital format via a digital interface without displaying it. It may optionally have one or more keys (or mouse, touch-screen, etc.) to operate the instrument.

T.2.2.5 Terminal

Digital device that has one or more keys (or mouse, touch-screen, etc.) to operate the instrument, and a display to provide the weighing results transmitted via the digital interface of a weighing module or an analog data processing device.

T.2.2.6 Digital display

A digital display can be realized as a primary display or as a secondary display:

- a) Primary display: Either incorporated in the indicator housing or in the terminal housing or realized as a display in a separate housing (i.e. terminal without keys), e.g. for use in combination with a weighing module.
- b) Secondary display: Additional peripheral device (optional) which repeats the weighing result and any other primary indication, or provides further, non-metrological information.

Note: The terms “primary display” and “secondary display” should not be confused with the terms “primary indication” and “secondary indication” (T.1.3.1 and T.1.3.2)

T.2.2.7 Weighing module

Part of the weighing instrument that comprises all mechanical and electronic devices (i.e. load receptor, load-transmitting device, load cell, and analog data processing device or digital data processing device) but not having the means to display the weighing result. It may optionally have devices for further processing (digital) data and operating the instrument.

T.2.3 Electronic parts

T.2.3.1 Electronic device [OIML D 11: 2004, 3.2]

Device employing electronic sub-assemblies and performing a specific function.

Electronic devices are usually manufactured as separate units and are capable of being tested independently.

Note: An electronic device, as defined above, may be a complete instrument (e.g. an instrument for direct sales to the public), a module (e.g. indicator, analog data processing device, weighing module) or a peripheral device (e.g. printer, secondary display).

T.2.3.2 Electronic sub-assembly [OIML D 11: 2004, 3.3]

Part of an electronic device, employing electronic components and having a recognizable function of its own.

Examples: A/D converter, display.

T.2.3.3 Electronic component [OIML D 11: 2004, 3.4]

Smallest physical entity that uses electron or hole conduction in semi-conductors, gases or in a vacuum.

Examples: Electronic tube, transistor, integrated circuit.

T.2.3.4 Digital device

Electronic device that only performs digital functions and provides a digitized output or display.

Examples: Printer, primary or secondary display, keyboard, terminal, data storage device, personal computer.

T.2.3.5 Peripheral device

Additional device which repeats or further processes the weighing result and other primary indications.

Examples: Printer, secondary display, keyboard, terminal, data storage device, personal computer.

T.2.3.6 Protective interface

Interface (hardware and/or software) which only allows the introduction of such data into the data processing device of an instrument, module or electronic component, which cannot:

- display data which are not clearly defined and which could be taken for a weighing result;
- falsify displayed, processed or stored weighing results or primary indications; or
- adjust the instrument or change any adjustment factor, except releasing an adjustment procedure with incorporated devices or, in the case of class I instruments with external adjustment weights as well.

T.2.4 Displaying device (of a weighing instrument)

Device providing the weighing result in visual form.

T.2.4.1 Displaying component

Component that displays the equilibrium and/or the result.

- On an instrument with one position of equilibrium it displays only the equilibrium.
- On an instrument with several positions of equilibrium it displays both the equilibrium and the result.

T.2.4.2 Scale mark

Line or other mark on a displaying component corresponding to a specified value of mass.

T.2.5 Auxiliary indicating devices

T.2.5.1 Rider

Detachable poise of small mass that may be placed and moved either on a graduated bar integral with the beam or on the beam itself.

T.2.5.2 Device for interpolation of reading (vernier or nonius)

Device connected to the displaying component and sub-dividing the scale of an instrument, without special adjustment.

T.2.5.3 Complementary displaying device

Adjustable device by means of which it is possible to estimate, in units of mass, the value corresponding to the distance between a scale mark and the displaying component.

T.2.5.4 Indicating device with a differentiated scale division

Digital indicating device of which the last figure after the decimal sign is clearly differentiated from other figures.

T.2.6 Extended displaying device

Device temporarily changing the actual scale interval, d , to a value less than the verification scale interval, e , following a manual command.

T.2.7 Supplementary devices

T.2.7.1 Leveling device

Device for setting an instrument to its reference (horizontal) position.

T.2.7.2 Zero-setting device

Device for setting the indication to zero when there is no load on the load receptor.

T.2.7.2.1 Non-automatic zero-setting device

Device for setting the indication to zero by an operator.

T.2.7.2.2 Semi-automatic zero-setting device

Device for setting the indication to zero automatically following a manual command.

T.2.7.2.3 Automatic zero-setting device

Device for setting the indication to zero automatically without the intervention of an operator.

T.2.7.2.4 Initial zero-setting device

Device for setting the indication to zero automatically at the time the instrument is switched on and before it is ready for use.

T.2.7.3 Zero-tracking device

Device for maintaining the zero indication within certain limits automatically.

T.2.7.4 Tare device

Device for setting the indication to zero when a load is on the load receptor:

- without altering the weighing range for net loads (additive tare device); or
- reducing the weighing range for net loads (subtractive tare device).

It may function as:

- a non-automatic device (load balanced by an operator);
- a semi-automatic device (load balanced automatically following a single manual command);
or
- an automatic device (load balanced automatically without the intervention of an operator).

T.2.7.4.1 Tare-balancing device

Tare device without indication of the tare value when the instrument is loaded.

T.2.7.4.2 Tare-weighing device

Tare device that stores the tare value and that is capable of displaying or printing it whether or not the instrument is loaded.

T.2.7.5 Preset tare device

Device for subtracting a preset tare value from a gross or net weight value and indicating the result of the calculation. The weighing range for net loads is reduced accordingly.

T.2.7.6 Locking device

Device for immobilizing all or part of the mechanism of an instrument.

T.2.7.7 Auxiliary verification device

Device permitting separate verification of one or more main devices of an instrument.

T.2.7.8 Selection device for load receptors and load-measuring devices

Device for attaching one or more load receptors to one or more load-measuring devices, whatever intermediate load-transmitting devices are used.

T.2.8 Software

T.2.8.1 Legally relevant software

Programs, data, type-specific and device-specific parameters that belong to the measuring instrument or module, and define or fulfill functions which are subject to legal control.

Examples: Final results of the measurement, i.e. gross, net and tare / preset tare value (including the decimal sign and the unit), identification of the weighing range and the load receptor (if several load receptors have been used), software identification.

T.2.8.2 Legally relevant parameter

Parameter of a measuring instrument or a module subject to legal control. The following types of legally relevant parameters can be distinguished: type-specific parameters and device-specific parameters.

T.2.8.3 Type-specific parameter

Legally relevant parameter with a value that depends on the type of instrument only. Type-specific parameters are part of the legally relevant software. They are fixed at type approval of the instrument.

Examples: Parameters used for mass calculation, stability analysis or price calculation and rounding, software identification.

T.2.8.4 Device-specific parameter

Legally relevant parameter with a value that depends on the individual instrument. Device-specific parameters comprise calibration parameters (e.g. span adjustment or other adjustments or corrections) and configuration parameters (e.g. maximum capacity, minimum capacity, units of measurement, etc.).

They are adjustable or selectable only in a special operational mode of the instrument. Device-specific parameters may be classified as those that should be secured (unalterable) and those that may be accessed (settable parameters) by an authorized person.

T.2.8.5 Long-term storage of measurement data

Storage used for keeping measurement data ready after completion of the measurement for later legally relevant purposes (e.g. conclusion of a trading transaction at a later date, when the customer is not present for the determination of the amount, or for special applications identified and legislated by the state).

T.2.8.6 Software identification

Sequence of readable characters of software that is inextricably linked to the software (e.g. version number, checksum).

T.2.8.7 Software separation

Unambiguous separation of software into legally relevant software and non-legally relevant software. If no software separation exists, the whole software is to be considered as legally relevant.

T.2.9 Metrologically relevant

Any device, module, part, component or function of a weighing instrument that may influence the weighing result or any other primary indication is considered as metrologically relevant.

T.3 Metrological characteristics of an instrument

T.3.1 Weighing capacity

T.3.1.1 Maximum capacity (Max)

Maximum weighing capacity, not taking into account the additive tare capacity.

T.3.1.2 Minimum capacity (Min)

Value of the load below which the weighing results may be subject to an excessive relative error.

T.3.1.3 Self-indication capacity

Weighing capacity within which equilibrium is obtained without the intervention of an operator.

T.3.1.4 Weighing range

Range between the minimum and maximum capacities.

T.3.1.5 Extension interval of self-indication

Value by which it is possible to extend the range of self-indication within the weighing range.

T.3.1.6 Maximum tare effect (T = + ..., T = - ...)

Maximum capacity of the additive tare device or the subtractive tare device.

T.3.1.7 Maximum safe load (*Lim*)

Maximum static load that can be carried by the instrument without permanently altering its metrological qualities.

T.3.2 Scale divisions

T.3.2.1 Scale spacing (instrument with analog indication)

Distance between any two consecutive scale marks.

T.3.2.2 Actual scale interval, *d*

Value, expressed in units of mass of:

- the difference between the values corresponding to two consecutive scale marks, for analog indication; or
- the difference between two consecutive indicated values, for digital indication.

T.3.2.3 Verification scale interval, *e*

Value, expressed in units of mass, used for the classification and verification of an instrument.

T.3.2.4 Scale interval used for numbering

Value of the difference between two consecutive numbered scale marks.

T.3.2.5 Number of verification scale intervals, *n*

Quotient of the maximum capacity and the verification scale interval:

$$n = \text{Max} / e$$

T.3.2.6 Multi-interval instrument

Instrument having one weighing range which is divided into partial weighing ranges each with different scale intervals, with the partial weighing range determined automatically according to the load applied, both on increasing and decreasing loads.

T.3.2.7 Multiple range instrument

Instrument having two or more weighing ranges with different maximum capacities and different scale intervals for the same load receptor, each range extending from zero to its maximum capacity.

T.3.3 Reduction ratio, *R*

The reduction ratio of a load transmitting device is:

$$R = F_M / F_L$$

where: F_M = force acting on the load measuring device,

F_L = force acting on the load receptor.

T.3.4 Type

Definitive model of a weighing instrument or module (including a family of instruments or modules) of which all of the elements affecting its metrological properties are suitably defined.

T.3.5 Family [*adapted from OIML B 3: 2003, 2.3*]

Identifiable group of weighing instruments or modules belonging to the same manufactured type that have the same design features and metrological principles for measurement (for example the same type of indicator, the same type of design of load cell and load transmitting device) but which may differ in some metrological and technical performance characteristics (e.g. Max, Min, e , d , accuracy class, etc.).

The concept of a “family” primarily aims to reduce the testing required at type examination. It does not preclude the possibility of listing more than one family in one Certificate.

T.4 Metrological properties of an instrument

T.4.1 Sensitivity

For a given value of the measured mass, the quotient of the change, Δl , of the observed variable, l , and the corresponding change, Δm , of the measured mass, m .

T.4.2 Discrimination

Ability of an instrument to react to small variations of load.

The discrimination threshold, for a given load, is the value of the smallest additional load that, when gently deposited on or removed from the load receptor, causes a perceptible change in the indication.

T.4.3 Repeatability

Ability of an instrument to provide results that agree one with the other when the same load is deposited several times and in a practically identical way on the load receptor under reasonably constant test conditions.

T.4.4 Durability

Ability of an instrument to maintain its performance characteristics over a period of use.

T.4.5 Warm-up time

Time between the moment power is applied to an instrument and the moment at which the instrument is capable of complying with the requirements of this Recommendation.

T.4.6 Final weight value

Weight value that is achieved when the instrument is completely at rest and balanced, with no disturbances affecting the indication.

T.5 Indications and errors

T.5.1 Methods of indication

T.5.1.1 Balancing by weights

Value of metrologically controlled weights that balances the load (taking into account the reduction ratio of the load).

T.5.1.2 Analog indication

Indication enabling the evaluation of the equilibrium position to a fraction of the scale interval.

T.5.1.3 Digital indication

Indication in which the scale marks are composed of a sequence of aligned figures that do not permit interpolation to fractions of the scale interval.

T.5.2 Weighing results

Note: The definitions in T.5.2 apply only when the indication has been zero before the load has been applied to the instrument.

T.5.2.1 Gross value, G or B

Indication of the weight value of a load on an instrument, with no tare or preset tare device in operation.

T.5.2.2 Net value, N

Indication of the weight value of a load placed on an instrument after operation of a tare device.

T.5.2.3 Tare value, T

Weight value of a load, determined by a tare weighing device.

T.5.3 Other weight values

T.5.3.1 Preset tare value, PT

Numerical value, representing a weight, that is introduced into the instrument and is intended to be applied to other weighings without determining individual tares.

“Introduced” includes procedures such as: keying in, recalling from a data storage device, or inserting via an interface.

T.5.3.2 Calculated net value

Value of the difference between a measured weight value (gross or net) and a preset tare value.

T.5.3.3 Calculated weight value

Calculated sum or difference of more than one measured weight value and/or calculated net value.

T.5.4 Reading

T.5.4.1 Reading by simple juxtaposition

Reading of the weighing result by simple juxtaposition of consecutive figures giving the weighing result, without the need of calculation.

T.5.4.2 Overall inaccuracy of reading

On an instrument with analog indication, this is equal to the standard deviation of the same indication, the reading of which is carried out under normal conditions of use by several observers.

It is customary to make at least ten readings of the result.

T.5.4.3 Rounding error of digital indication

Difference between the indication and the result the instrument would give with analog indication.

T.5.4.4 Minimum reading distance

Shortest distance that an observer is able freely to approach the displaying device to take a reading under normal conditions of use.

This approach is considered to be free for the observer if there is a clear space of at least 0.8 m in front of the displaying device (see Figure 2).

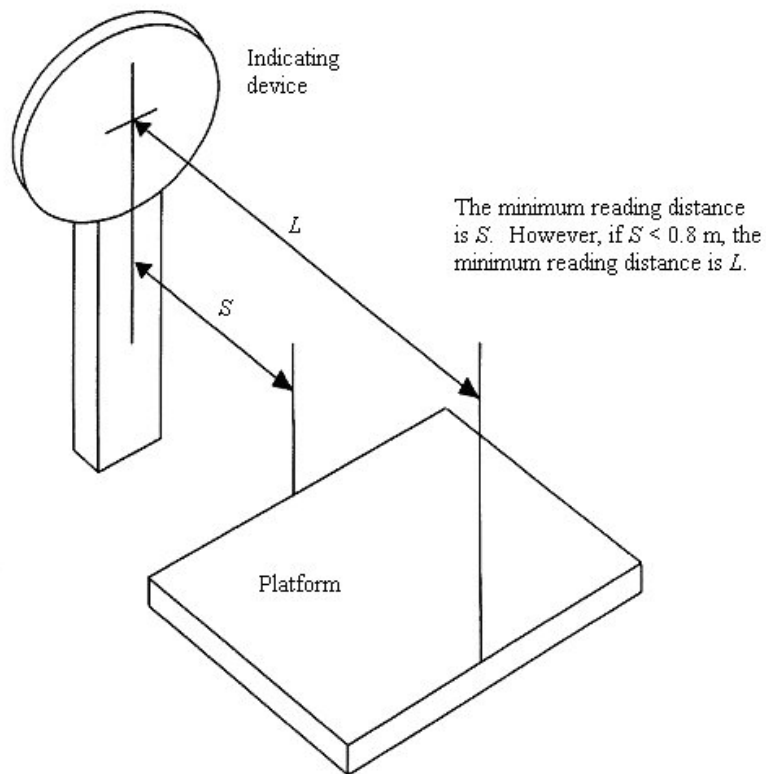

Figure 2

T.5.5 Errors

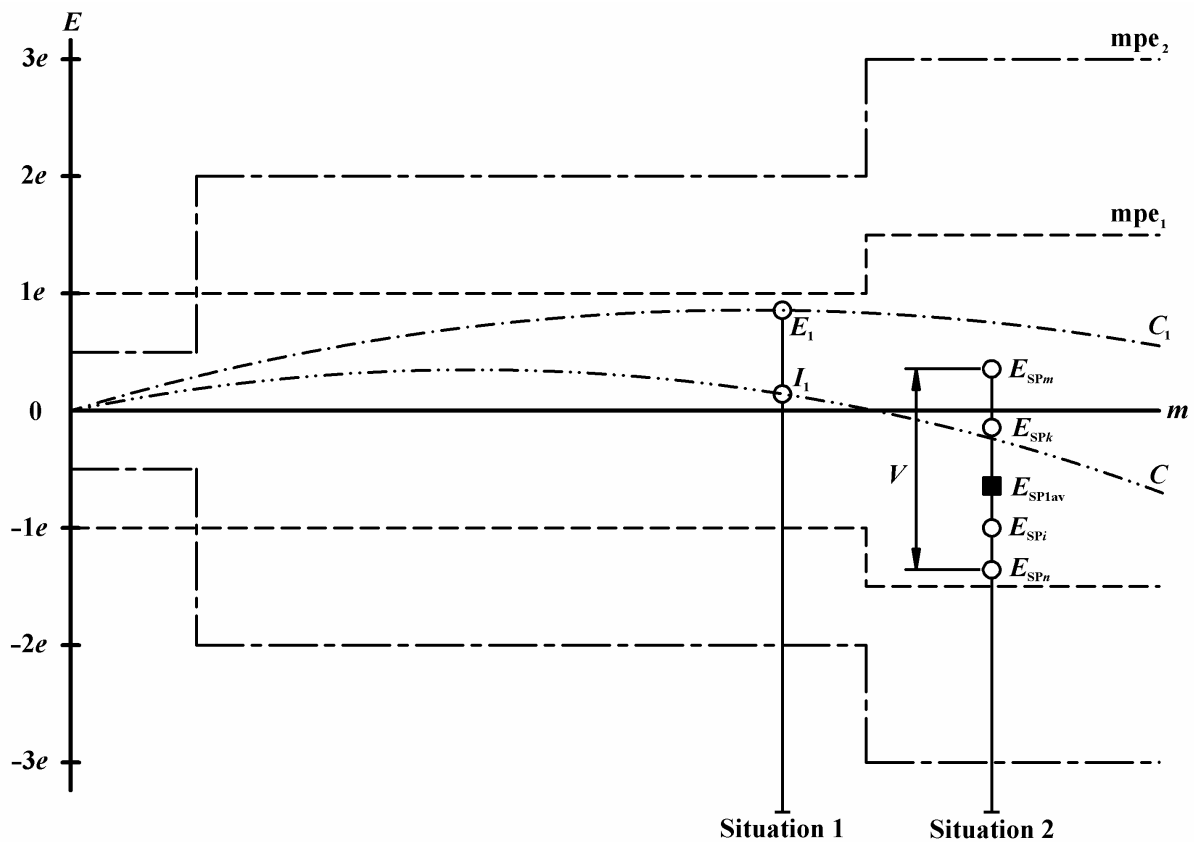

Figure 3

m = mass to be measured

E = error of indication (T.5.5.1)

mpe_1 = maximum permissible error on initial verification

mpe_2 = maximum permissible error in service

C = characteristic under reference conditions

C_1 = characteristic due to influence factor or disturbance

(For the purposes of this illustration it is supposed that the influence factor or the disturbance has an influence on the characteristic which is not erratic)

E_{SP} = error of indication evaluated during span stability test

I = intrinsic error (T.5.5.2)

V = variation in the errors of indication during span stability test

Situation 1: shows the error E_1 of an instrument due to an influence factor or a disturbance. I_1 is the intrinsic error. The fault (T.5.5.5) due to the influence factor or disturbance applied equals $E_1 - I_1$.

Situation 2: shows the average value, E_{SP1av} , of the errors at the first measurement of the span stability test, some other errors (E_{SPi} , and E_{SPk}) and the extreme values of the errors E_{SPm} and E_{SPn} , all these errors being evaluated at different moments during the span stability test. The variation, V , in the errors of indication during the span stability test equals $E_{SPm} - E_{SPn}$.

T.5.5.1 Error (of indication) [adapted from VIM 1993, 3.10]

Indication of an instrument minus the (conventional) true value of the corresponding mass.

T.5.5.2 Intrinsic error [VIM: 1993, 5.4]

Error of an instrument determined under reference conditions.

T.5.5.3 Initial intrinsic error

Intrinsic error of an instrument as determined prior to the performance and span stability tests.

T.5.5.4 Maximum permissible error, mpe

Maximum difference, positive or negative, allowed by regulation between the indication of an instrument and the corresponding true value, as determined by reference standard masses or standard weights, with the instrument being at zero at no-load, in the reference position.

T.5.5.5 Fault

Difference between the error of indication and the intrinsic error of an instrument.

Note: Principally, a fault is the result of an undesired change of data contained in or flowing through an electronic instrument.

T.5.5.6 Significant fault

Fault greater than e .

Note: For a multi-interval instrument, the value of e is that appropriate to the partial weighing range.

The following are not considered to be significant faults, even when they exceed e :

- faults arising from simultaneous and mutually independent causes in the instrument;
- faults implying the impossibility to perform any measurement;
- faults being so serious that they are bound to be noticed by all those interested in the result of measurement; or
- transitory faults, being momentary variations in the indication which cannot be interpreted, memorized or transmitted as a measuring result.

T.5.5.7 Durability error

Difference between the intrinsic error over a period of use and the initial intrinsic error of an instrument.

T.5.5.8 Significant durability error

Durability error greater than e .

Note 1: A durability error can be due to mechanical wear and tear or due to drift and ageing of electronic parts. The concept of significant durability error applies only to electronic parts.

Note 2: For a multi-interval instrument, the value of e is that appropriate to the partial weighing range.

Errors, occurring after a period of instrument use, are not considered to be significant durability errors, even when they exceed e , if they are clearly the result of the failure of a device/component, or of a disturbance and for which the indication:

- cannot be interpreted, memorized, or transmitted as a measurement result;
- implies the impossibility to perform any measurement; or
- is so obviously wrong that it is bound to be noticed by all those interested in the result of measurement.

T.5.5.9 Span stability

Capability of an instrument to maintain the difference between the indication at maximum capacity and the indication at zero over a period of use within specified limits.

T.6 Influences and reference conditions

T.6.1 Influence quantity

Quantity that is not the subject of the measurement but which influences the values of the measurand or the indication of the instrument.

T.6.1.1 Influence factor

Influence quantity having a value within the specified rated operating conditions of the instrument.

T.6.1.2 Disturbance

Influence quantity having a value within the limits specified in this Recommendation, but outside the specified rated operating conditions of the instrument.

T.6.2 Rated operating conditions [VIM: 1993, 5.5]

Conditions of use, giving the range of values of influence quantities for which the metrological characteristics are intended to lie within the specified maximum permissible errors.

T.6.3 Reference conditions

Set of specified values of influence factors fixed to ensure valid inter-comparison of the results of measurements.

T.6.4 Reference position

Position of the instrument at which its operation is adjusted.

T.7 Performance test

Test to verify whether the equipment under test (EUT) is capable of performing its intended functions.

T.8 Index of terms defined

The numbers in brackets refer to important chapters of this Recommendation.

Actual scale interval	(3.4.3, 3.5.3.2, 3.8.2.2, A.4.8.2).....	T.3.2.2
Analog data processing device	(3.10.2.2, 3.10.2.4, F.3).....	T.2.2.3
Analog indication	(3.8.2.1, 4.6.3, A.4.8.1).....	T.5.1.2
Automatic zero-setting device	(4.5.6, A.4.1.5, A.4.2.1.3).....	T.2.7.2.3
Auxiliary indicating devices	(3.1.2, 3.4, 4.13.7).....	T.2.5
Auxiliary verification device.....	(3.7.2, 4.9).....	T.2.7.7
Calculated net value	(4.7.1).....	T.5.3.2
Calculated weight value	(4.6.11).....	T.5.3.3
Complementary indicating device	(3.4.1, 4.3.2).....	T.2.5.3
Device for interpolation of reading	(3.4.1).....	T.2.5.2
Device-specific parameter	(4.1.2.4, 7.1.4, G.2.2.3).....	T.2.8.4
Digital indication.....	(3.5.3.2, 3.8.2.2, 4.2.2.2, 4.5.5, 4.13.6, A.4.1.6, A.4.4.3, A.4.8.2).....	T.5.1.3
Digital device	(3.10.2.1, 3.10.4.6, 4.13.6, F.5, G).....	T.2.3.4
Digital display	(3.10.2.4, C.1).....	T.2.2.6
Discrimination	(3.8, 6.1, A.4.8).....	T.4.2
Displaying component.....	(4.3, 6.2, 6.3, 6.6).....	T.2.4.1
Displaying device.....	(2.4, 3.6.3, 4.2.1, 4.2.4, 4.3, 4.4, 4.17.1, 6.2, A.4.5, E.2.2).....	T.2.4
Disturbance	(3.10.2.2, 3.10.3, 5.1.1, 5.3, 5.4.3, B.3).....	T.6.1.2
Durability	(3.9.4.3, A.6).....	T.4.4
Durability error.....	(3.9.4.3, A.6).....	T.5.5.7
Electronic component.....	(4.1.2.4).....	T.2.3.3
Electronic device	(5.5).....	T.2.3.1
Electronic instrument	(2.3, 5, B).....	T.1.2.6
Electronic sub-assembly.....	(4.1.2.4).....	T.2.3.2
Error (of indication)	(2.2, 3.1.1, 3.5, 3.6, 5.1.1, 8.3.3).....	T.5.5.1
Extended displaying device.....	(3.4.1, 4.4.3, 4.13.7).....	T.2.6
Extension interval of self-indication.....	(4.2.5).....	T.3.1.5
Family	(3.10.4, 8.2.1).....	T.3.5
Fault	(5.1, 5.2).....	T.5.5.5
Final weight value	(4.4.2).....	T.4.6
Grading instrument.....	(3.2).....	T.1.2.13
Graduated instrument	(3.1.2).....	T.1.2.1
Gross value.....	(4.6.5, 4.13.3).....	T.5.2.1
Indications of an instrument	(3.8.2, 4.2, 4.3.3, 4.4, 4.6.12).....	T.1.3
Indicating device with a differentiated scale division.....	(3.4.1).....	T.2.5.4
Indicator	(3.10.2, 5.3.1, 5.5.2, 7.1.5.3, C, F).....	T.2.2.2
Influence factor	(3.5.3.1, 5.4.3, A.5).....	T.6.1.1
Initial intrinsic error	(A.4.4.1).....	T.5.5.3
Initial zero-setting device	(4.5.1, 4.5.4, A.4.4.2).....	T.2.7.2.4
Instrument with price scales	(4.14.2).....	T.1.2.7
Intrinsic error.....	(5.3.4, A.4.4.1, A.6).....	T.5.5.2
Legally relevant parameter.....	(5.5.2.2, 5.5.3).....	T.2.8.2
Legally relevant software	(5.5.2, 5.5.3, G.1, G.2).....	T.2.8.1
Leveling device	(3.9.1, 4.18.2).....	T.2.7.1
Load cell.....	(3.10.2.1, 3.10.2.4, 7.1.5.3, C, F).....	T.2.2.1
Load-measuring device	(2.4, 6.9, 4.11, 7.1.5.1).....	T.2.1.3
Load receptor	(3.6, 4.11, 7.1.5.1, A.4.7).....	T.2.1.1
Load-transmitting device.....	(3.10.2.1, 4.11).....	T.2.1.2
Locking device.....	(4.8.1).....	T.2.7.6
Long-term storage of measurement data	(5.5.3).....	T.2.8.5
Maximum capacity	(3.3, 4.13, 6.6, 6.8).....	T.3.1.1
Maximum permissible error	(2.2, 3.1, 3.5, A.4.4.1).....	T.5.5.4
Maximum safe load.....	(7.1.2).....	T.3.1.7
Maximum tare effect	(A.4.6.1).....	T.3.1.6
Metrologically relevant	(3.10.4).....	T.2.9
Minimum capacity	(2.2, 3.2, 3.4.3).....	T.3.1.2
Minimum reading distance.....	(4.3.1, 4.3.2).....	T.5.4.4
Mobile instrument	(3.9.1.1, 4.18, A.4.7.5, A.4.12, A.5.1.3).....	T.1.2.11
Module	(3.10.2, 5.5.2, 7.1.5.3, C, E, F).....	T.2.2
Multi-interval instrument	(3.3, 3.4.1).....	T.3.2.6
Multiple range instrument	(3.2, 4.5.3, 4.6.7, 4.10).....	T.3.2.7
Net value	(3.5.3.3, 4.6.5, 4.6.11).....	T.5.2.2
Non-automatic weighing instrument	(1 etc.).....	T.1.2

Non-automatic zero-setting device	(4.13.2)	T.2.7.2.1
Non-graduated instrument	(3.1.2)	T.1.2.2
Non-self-indicating instrument	(3.8.1, 6)	T.1.2.5
Number of verification scale intervals	(2.2, 3.2, 3.3.1, 3.4.4, C.1.2, E.1.2.3, F)	T.3.2.5
Overall inaccuracy of reading	(4.2.1)	T.5.4.2
Performance test	(5.4, A.4, B.3, B.4, C.2.2.1, C.2.4, C.3.1)	T.7
Peripheral device	(3.10.3, 5.3.6, 5.5.2, 7.1.5.4, B.3)	T.2.3.5
Portable instrument	(4.3.4, 4.19, A.4.13)	T.1.2.12
Preset tare device	(2.4, 4.7, 4.13.4)	T.2.7.5
Preset tare value	(3.5.3.3, 4.7, 4.13.4, 4.16)	T.5.3.1
Price-computing instrument	(4.13.11, 4.14)	T.1.2.8
Price-labeling instrument	(4.16)	T.1.2.9
Primary indications	(4.4.4, 4.4.6, 4.13, 4.14.1, 4.14.4, 5.3.6.1, 5.3.6.3, 5.5.2.1)	T.1.3.1
Protective interface	(3.10.3, 5.5.2.2)	T.2.3.6
Reading by simple juxtaposition	(4.2.1)	T.5.4.1
Reduction ratio	(6.2.3, F.1, F.2.7)	T.3.3
Reference position	(3.9.1.1, 6.2.1.3, 6.3.1, A.4.1.4, A.4.3, A.5.1)	T.6.4
Repeatability	(3.6.1, 3.7.3, 8.3.3, A.4.1.7, A.4.4.5, A.4.10, C.2.7, C.3.1.1)	T.4.3
Rider	(3.4.1)	T.2.5.1
Rounding error or digital indication	(3.5.3.2, B.3)	T.5.4.3
Scale interval used for numbering	(4.3.1)	T.3.2.4
Scale mark	(4.3.1, 4.17.2, 6.2, 6.3, 6.6.1.1)	T.2.4.2
Scale spacing	(4.3, 6.2.2.2, 6.6.1.1, 6.9.3)	T.3.2.1
Secondary indications	(4.2.4)	T.1.3.2
Selection device for load receptors and load-measuring devices	(4.11)	T.2.7.8
Self-indicating instrument	(3.8.2, 4, 5, 6)	T.1.2.3
Self-indication capacity	(3.6.4, 3.9.1.1, 4.2.5)	T.3.1.3
Self-service instrument	(4.13.11)	T.1.2.10
Semi-automatic zero-setting device	(4.5.4, 4.6.5, 4.6.9)	T.2.7.2.2
Semi-self-indicating instrument	(3.8.2, 4.2.5, 4.12, 4.17, 5)	T.1.2.4
Sensitivity	(4.1.2.4, 6.1, A.4.9)	T.4.1
Significant fault	(4.13.9, 5.1, 5.2, 5.3.4, B.1, B.3)	T.5.5.6
Software	(4.1.2.4, 5.5.1, 5.5.2.2, 5.5.3, 7.1.4, 8.2.1.2, C.1, E.1, G)	T.2.8
Software identification	(5.5.1, 5.5.2.2, 7.1.2, 8.3.2, G.1, G.2.4)	T.2.8.6
Software separation	(5.5.2.2, G.2.3)	T.2.8.7
Span stability	(3.10, 5.3.3, 5.4, B.4)	T.5.5.9
Tare-balancing device	(4.6)	T.2.7.4.1
Tare device	(3.3.4, 4.2.3, 4.6, 4.13.3, 6.3.5, A.4.6.2)	T.2.7.4
Tare value	(3.5.3.4, 4.6.5, 4.6.11, 4.13.3.2, 5.5.3.2, A.4.6.1, C.3.2, G.3.3)	T.5.2.3
Tare-weighing device	(3.5.3.4, 3.6.3, 4.2.2.1, 4.5.4, 4.6.2, A.4.6.3)	T.2.7.4.2
Terminal	(3.10.2.4, 5.5.2, C.1, E.2.2)	T.2.2.5
Type	(2.3 etc.)	T.3.4
Type specific parameter	(5.5.2.2, G.2.2, G.2.4)	T.2.8.3
Verification scale interval	(2.2, 3.1.2, 3.2, 3.3.1, 3.4, 3.5.1)	T.3.2.3
Warm-up time	(5.3.5, A.5.2, B.1, B.3)	T.4.5
Weighing instrument	(1)	T.1.1
Weighing module	(3.10.2, 7.1.5.3, E.1, E.2, E.3, E.4)	T.2.2.7
Weighing range	(3.2, 3.3, 3.9.5, 4.2.3, 4.10)	T.3.1.4
Weighing results	(3.6, 4.2, 4.3.1, 4.4.4, 4.6.11, 4.6.12, 4.13.1)	T.5.2
Zero-setting device	(4.5, 4.6.5, 4.13.2, 6.4.2, 6.6, 6.7, 6.8, A.4.2.1.3, A.4.2.3.1)	T.2.7.2
Zero-tracking device	(4.5, A.4.1.5)	T.2.7.3

T.9 Abbreviations and symbols

This Recommendation concerns metrological terms as well as technical and physical terms. Therefore ambiguity of abbreviations and symbols is not excluded. With the following explanations, however, any confusion should be avoided.

α	temperature coefficient of cable material	C.3.3.2.4
ρ	specific resistance of cable material	C.3.3.2.4
A	load cell classification	F.2 Table 13, F.4
A	cross section of a single wire	C.3.3.2.4, F.1, F.4
AC	alternating current	3.9.3 etc.
A/D	analog-to-digital	T.2.2
ADC	relevant analog components, including Analog/Digital-Converter	T.2.2 Figure 1, 5.5.2.1 Table 11
B	load cell classification	F.2 Table 13, F.4
B	gross weight value	T.5.2.1, 4.6.11
C	load cell classification	F.2 Table 13, F.4
C	mark for calculated weight value, when printed	4.6.11
C	rated output of a load cell	F.2, F.4
CH	additional load cell classification: cyclic temperature humidity tested	3.10.4.1, F.2, R 60: 4.6.5.2
CRC	cyclic redundancy check	5.5.3.3
d	(actual) scale interval	T.3.2.2, T.2.6, 6.9.3
D	load cell classification	F.2 Table 13, F.4
DC	direct current	3.9.3 etc.
DL	dead load of load receptor	F.1, F.2.5, F.4
DR	dead load return	F.2, F.4
DSD	data storage device	5.5.3
e	verification scale interval	T.2.6, 3.1.2, 3.2, 4.2.2.1
e_1, e_b, e_r	verification scale interval, rules for indices	3.2, F.1, F.4
E	error of indication	T.5.5.1, Figure 3, A.4.4.3
E_{in}	intrinsic error	T.5.5, Figure 3
E_{max}	maximum capacity of the load cell	F.2, F.4
E_{min}	minimum dead load for the load cell	F.2, F.4
EMC	electromagnetic compatibility	B.3.7
EUT	equipment under test	T.7, 3.10.4, Annex B
G	gross weight value	T.5.2.1, 4.6.11
i	variable indices	3.3 etc.
i, i_x	scale spacing	T.3.2.1, 4.3.2, 6.2.2.2
i_0	minimum scale spacing	4.3.2, 6.9.3
I	indicated weight value	A.4.4.3 (Evaluation of errors), A.4.8.2
I/O	input output	B.3.2
IZSR	initial zero setting range	F.1, F.4
k	variable exponent	3.4.2, 4.2.2.1
l, L	length of cable	C.3.3.2.4, F.1, F.4
L	reading distance	T.5.4.4, 4.3.2
L	load	A.4.4.3 (Evaluation of errors)
LC	load cell	Annex F
Lim	maximum safe load	7.1.2
M	mass	3.5.1 etc.
Max	maximum capacity of the weighing instrument	T.3.1.1, F.1, F.4
Max_1, Max_i, Max_r	maximum capacity of the weighing instrument, rules for indices	3.2, F.1, F.4
Min	minimum capacity of the weighing instrument	T.3.1.2
mpe	maximum permissible error	T.5.5, T.5.5.4, 3.5 etc.
n, n_i	number of verification scale intervals	T.3.2.5, F.4
n_{max}	maximum number of verification scale intervals	3.10.4.6 etc.

n_{WI}	maximum number of verification scale intervals of the weighing instrument	F.1, F.4
n_{ind}	maximum number of verification scale intervals for an indicator	F.3, F.4
n_{LC}	maximum number of load cell verification intervals	F.2, F.4
N, NET, Net, net	net value	T.5.2.2, 4.6.5, 4.6.11
N	number of load cells	F.1, F.4
NH	additional load cell classification: not humidity tested	3.10.2.4, F.2, R 60: 4.6.5.1
NUD	correction for non uniform distributed load	F.1, F.4
p, p_i	apportioning factor of mpe	3.10.2.1
p_{ind}, p_{LC}, p_{con}	fraction of mpe for indicator, load cell and conducting elements	3.10.2.1, F.4
P	indication prior to rounding	A.4.4.3 (Evaluation of errors)
P	price to pay	4.14.2
PLU	price look up (unit, storage)	4.13.4
PT	preset tare	T.2.7.5, 4.7
Q	correction factor	F.1, F.4
R	reduction ratio of a load transmitting device	T.3.3
R_{cable}	resistance of a single wire	C.3.3.2.4
R_L, R_{Lmin}, R_{Lmax}	load resistance for an indicator	F.3, F.4
R_{LC}	input resistance of a load cell	F.2, F.4
SH	additional load cell classification: static temperature humidity tested	3.10.2.4, F.2, R 60: 4.6.5.3
T	tare value	T.5.2.3, 4.6.5, 4.6.11
T^+	additive tare	7.1.2 etc.
T^-	subtractive tare	7.1.2 etc.
T_{min}, T_{max}	lower limit of temperature range, upper limit of temperature range	C.3.3.2.4
u_m	unit of measurement	2.1, 4.12.1
Δu_{min}	minimum input voltage per verification scale interval	C.2.1.1, F.3, F.4
U	unit price	4.14.2
U	nominal voltage of power supply	3.9.3, A.5.4
U_{min}, U_{max}	voltage range of power supply	3.9.3, A.5.4
U_{exc}	load cell excitation voltage	F.1, F.4
U_{min}	minimum input voltage for indicator	F.3, F.4
U_{MRmin}	measuring range minimum voltage for indicator	F.3
U_{MRmax}	measuring range maximum voltage for indicator	F.3
v_{min}	minimum load cell verification interval	F.2, F.4
V	variation in the error	Figure 3
W	weight	4.14.2
W1, W2	weighing instrument 1, weighing instrument 2	7.1.4
WI	weighing instrument	F.1
WR	weighing range	F
Y	ratio to minimum load cell verification interval: $Y = E_{max} / v_{min}$	F.2, F.4
Z	ratio to minimum load cell dead load output return: $Z = E_{max} / (2 \times DR)$	F.2, F.4

Non-automatic weighing instruments

1 Scope

This Recommendation specifies the metrological and technical requirements for non-automatic weighing instruments that are subject to official metrological control.

It is intended to provide standardized requirements and testing procedures to evaluate the metrological and technical characteristics in a uniform and traceable way.

2 Principles of the Recommendation

2.1 Units of measurement

The units of mass to be used on an instrument are

- the kilogram, kg;
- the milligram, mg;
- the gram, g; and
- the tonne, t.

For special applications, e.g. trade with precious stones, the metric carat (1 carat = 0.2 g) may be used as the unit of measurement. The symbol for the carat is ct.

2.2 Principles of the metrological requirements

The requirements apply to all instruments irrespective of their principles of measurement.

Instruments are classified according to:

- the verification scale interval, representing absolute accuracy; and
- the number of verification scale intervals, representing relative accuracy.

The maximum permissible errors are in the order of magnitude of the verification scale interval. They apply to gross loads and when a tare device is in operation they apply to the net loads. The maximum permissible errors do not apply to calculated net values when a preset tare device is in operation.

A minimum capacity (Min) is specified to indicate that use of the instrument below this value is likely to give rise to considerable relative errors.

2.3 Principles of the technical requirements

General technical requirements apply to all types of instruments, whether mechanical or electronic, and are supplemented or modified with additional requirements for instruments used for specific applications or designed for a special technology. They are intended to specify the performance, not the design of an instrument, so that technical progress is not impeded.

In particular, functions of electronic instruments not covered by this Recommendation should be allowed provided that they do not interfere with the metrological requirements, and if suitability for use and appropriate metrological control is ensured.

Testing procedures are provided to establish conformity of instruments with the requirements of this Recommendation. They should be applied, and the Test Report Format (R 76-2) should be used, to facilitate exchange and acceptance of test results by metrological authorities.

2.4 Application of requirements

The requirements of this Recommendation apply to all devices performing the relevant functions, whether they are incorporated in an instrument or manufactured as separate units. Examples are:

- load-measuring device;
- displaying device;
- printing device;
- preset tare device; and
- price-calculating device.

However, devices that are not incorporated in the instrument may, by national legislation, be exempted from the requirements for special applications.

2.5 Terminology

The terminology given in chapter T Terminology shall be considered as a binding part of this Recommendation.

3 Metrological requirements

3.1 Principles of classification

3.1.1 Accuracy classes

The accuracy classes for instruments and their symbols* are given in Table 1. Please note that the class denominations used in this Recommendation do not include the oval around the number for improved clarity of the Recommendation's text.

Table 1

Name	Symbol marked on instrument	Denomination used in this Recommendation
Special accuracy	⓪	I
High accuracy	Ⓛ	II
Medium accuracy	Ⓜ	III
Ordinary accuracy	Ⓜ	IIII

* Ovals of any shape, or two horizontal lines joined by two half-circles are permitted. A circle shall not be used because, in conformity with OIML R 34 *Accuracy classes of measuring instruments*, it is used for the designation of accuracy classes of measuring instruments of which the maximum permissible errors are expressed by a constant relative error in %.

3.1.2 Verification scale interval

The verification scale interval for different types of instruments is given in Table 2.

Table 2

Type of instrument	Verification scale interval
Graduated, without auxiliary indicating device	$e = d$
Graduated, with auxiliary indicating device	e is chosen by the manufacturer according to the requirements in 3.2 and 3.4.2
Non-graduated	e is chosen by the manufacturer according to the requirements in 3.2

3.2 Classification of instruments

The verification scale interval, number of verification scale intervals and the minimum capacity, in relation to the accuracy class of an instrument, are given in Table 3.

Table 3

Accuracy class	Verification scale interval, e	Number of verification scale intervals, $n = \text{Max}/e$		Minimum capacity, Min (Lower limit)
		minimum	maximum	
Special (I)	$0.001 \text{ g} \leq e^*$	50 000**	–	100 e
High (II)	$0.001 \text{ g} \leq e \leq 0.05 \text{ g}$	100	100 000	20 e
	$0.1 \text{ g} \leq e$	5 000	100 000	50 e
Medium (III)	$0.1 \text{ g} \leq e \leq 2 \text{ g}$	100	10 000	20 e
	$5 \text{ g} \leq e$	500	10 000	20 e
Ordinary (III)	$5 \text{ g} \leq e$	100	1 000	10 e

* It is not normally feasible to test and verify an instrument to $e < 1 \text{ mg}$, due to the uncertainty of the test loads.

** See exception in 3.4.4.

The minimum capacity is reduced to $5 e$ for grading instruments, i.e. instruments that determine a transport tariff or toll (e.g. postal scales and instruments weighing waste material).

On multiple range instruments the verification scale intervals are e_1, e_2, \dots, e_r with $e_1 < e_2 < \dots < e_r$. Similar subscripts are also used with the terms Min, n and Max.

On multiple range instruments, each range is treated as if it were an instrument with one range.

For special applications that are clearly marked on the instrument, an instrument may have weighing ranges in classes I and II, or in classes II and III. The instrument as a whole shall then comply with the more severe requirements of 3.9 applicable to either of the two classes.

3.3 Additional requirements for multi-interval instruments

3.3.1 Partial weighing range

Each partial range (index $i = 1, 2, \dots$) is defined by:

- its verification scale interval, $e_i, e_{i+1} > e_i$;
- its maximum capacity, Max_i ; and
- its minimum capacity, $\text{Min}_i = \text{Max}_{i-1}$ (for $i = 1$, the minimum capacity is $\text{Min}_1 = \text{Min}$).

The number of verification scale intervals, n_i , for each partial range is equal to Max_i / e_i .

3.3.2 Accuracy class

e_i and n_i in each partial weighing range, and Min_1 shall comply with the requirements given in Table 3 according to the accuracy class of the instrument.

3.3.3 Maximum capacity of partial weighing ranges

With the exception of the last partial weighing range, the requirements in Table 4 shall be complied with, according to the accuracy class of the instrument.

Table 4

Class	I	II	III	III
Max_i / e_{i+1}	$\geq 50\ 000$	$\geq 5\ 000$	≥ 500	≥ 50

Example for a multi-interval instrument:

Maximum capacity, $\text{Max} = 2 / 5 / 15$ kg, class III

Verification scale interval, $e = 1 / 2 / 10$ g

This instrument has one Max and one weighing range from $\text{Min} = 20$ g to $\text{Max} = 15$ kg. The partial weighing ranges are:

$\text{Min}_1 = 20$ g, $\text{Max}_1 = 2$ kg, $e_1 = 1$ g, $n_1 = 2\ 000$

$\text{Min}_2 = 2$ kg, $\text{Max}_2 = 5$ kg, $e_2 = 2$ g, $n_2 = 2\ 500$

$\text{Min}_3 = 5$ kg, $\text{Max}_3 = \text{Max} = 15$ kg, $e_3 = 10$ g, $n_3 = 1\ 500$

The maximum permissible errors on initial verification (mpe) (see 3.5.1) are:

for $m = 0$ g to 500 g mpe = $\pm 0.5 e_1$ = ± 0.5 g

for $m > 500$ g to 2 000 g mpe = $\pm 1 e_1$ = ± 1 g

for $m > 2\ 000$ g to 4 000 g mpe = $\pm 1 e_2$ = ± 2 g

for $m > 4\ 000$ g to 5 000 g mpe = $\pm 1.5 e_2$ = ± 3 g

for $m > 5\ 000$ g to 15 000 g mpe = $\pm 1 e_3$ = ± 10 g

Whenever the variation of the indication due to certain influence factors is limited to a fraction or multiple of e , this means, in a multi-interval instrument, that e is to be taken according to the load applied; particularly at or near zero, load $e = e_1$.

3.3.4 Instrument with a tare device

Requirements concerning the ranges of a multi-interval instrument apply to the net load, for every possible value of the tare.

3.4 Auxiliary indicating devices

3.4.1 Type and application

Only instruments of classes I and II may be fitted with an auxiliary indicating device, which shall be:

- a device with a rider;
- a device for interpolation of reading;
- a complementary displaying device (see Figure 4); or
- an indicating device with a differentiated scale division (see Figure 5).

These devices are permitted only to the right of the decimal sign.

A multi-interval instrument shall not be fitted with an auxiliary indicating device.

Note: Extended displaying devices (see T.2.6 and 4.4.3) are not regarded as auxiliary indicating devices.

Figure 4 – Example of a complementary displaying device

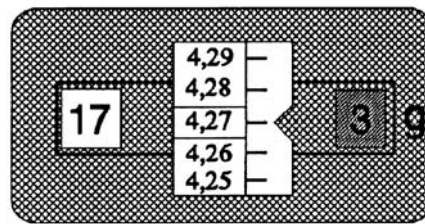

indication: 174.273 g
 last figure: 3
 $d = 1 \text{ mg}$
 $e = 10 \text{ mg}$

Figure 5 – Examples of indicating devices each with a differentiated scale division

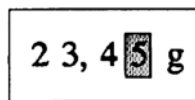

last differentiated figure: 5
 $d = 0.01 \text{ g}$ or 0.05 g
 $e = 0.1 \text{ g}$

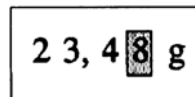

last differentiated figure: 8
 $d = 0.01 \text{ g}$ or 0.02 g
 $e = 0.1 \text{ g}$

3.4.2 Verification scale interval

The verification scale interval, e , is determined by the expression:

$$d < e \leq 10 d \text{ (see Tables 5a and 5b)}$$

$$e = 10^k \text{ kg}$$

k being a positive or negative whole number, or zero.

For a self- or semi-self-indicating instrument, see 4.2.2.1.

Table 5a – Example values of e , calculated following this rule

$d =$	0.1 g	0.2 g	0.5 g
$e =$	1 g	1 g	1 g
$e =$	$10 d$	$5 d$	$2 d$

This requirement does not apply to an instrument of class I with $d < 1 \text{ mg}$, where $e = 1 \text{ mg}$, as shown in the following Table.

Table 5b – Example values of e where $d < 1 \text{ mg}$

$d =$	0.01 mg	0.02 mg	0.05 mg	$< 0.01 \text{ mg}$
$e =$	1 mg	1 mg	1 mg	1 mg
$e =$	$100 d$	$50 d$	$20 d$	$> 100 d$

3.4.3 Minimum capacity

The minimum capacity of the instrument is determined in conformity with the requirements in Table 3. However, in the last column of this Table, the verification scale interval, e , is replaced by the actual scale interval, d .

3.4.4 Minimum number of verification scale intervals

For an instrument of class I with $d < 0.1$ mg, n may be less than 50 000.

3.5 Maximum permissible errors

3.5.1 Values of maximum permissible errors on initial verification

The maximum permissible errors for increasing or decreasing loads are given in Table 6.

Table 6

Maximum permissible errors on initial verification	For loads, m , expressed in verification scale intervals, e			
	Class I	Class II	Class III	Class IIII
$\pm 0.5 e$	$0 \leq m \leq 50\ 000$	$0 \leq m \leq 5\ 000$	$0 \leq m \leq 500$	$0 \leq m \leq 50$
$\pm 1.0 e$	$50\ 000 < m \leq 200\ 000$	$5\ 000 < m \leq 20\ 000$	$500 < m \leq 2\ 000$	$50 < m \leq 200$
$\pm 1.5 e$	$200\ 000 < m$	$20\ 000 < m \leq 100\ 000$	$2\ 000 < m \leq 10\ 000$	$200 < m \leq 1\ 000$

Note: The absolute value of the maximum permissible error is $0.5 e$, $1.0 e$ or $1.5 e$, i.e. it is the value of the maximum permissible error without the positive or negative sign.

Note: For multi-interval instruments, refer to 3.3 (including the example).

3.5.2 Values of maximum permissible errors in service

The maximum permissible errors in service shall be twice the maximum permissible errors on initial verification (see 8.4.2).

3.5.3 Basic rules concerning the determination of errors

3.5.3.1 Influence factors

Errors shall be determined under normal test conditions. When the effect of one factor is being evaluated, all other factors are to be kept relatively constant, at a value close to normal.

3.5.3.2 Elimination of rounding error

The rounding error included in any digital indication shall be eliminated if the actual scale interval is greater than $0.2 e$.

3.5.3.3 Maximum permissible errors for net values

The maximum permissible errors apply to the net value for every possible tare load, except preset tare values.

3.5.3.4 Tare weighing device

The maximum permissible errors for a tare weighing device are the same, for any tare value, as those of the instrument, for the same value of load.

3.6 Permissible differences between results

Regardless of what variation of results is permitted, the error of any single weighing result shall by itself not exceed the maximum permissible error for the given load.

3.6.1 Repeatability

The difference between the results of several weighings of the same load shall not be greater than the absolute value of the maximum permissible error of the instrument for that load.

3.6.2 Eccentric loading

The indications for different positions of a load shall meet the maximum permissible errors, when the instrument is tested according to 3.6.2.1-3.6.2.4.

Note: If an instrument is designed in such a way that loads may be applied in different manners, it may be appropriate to apply more than one of the following tests.

3.6.2.1 Unless otherwise specified hereafter, a load corresponding to 1/3 of the sum of the maximum capacity and the corresponding maximum additive tare effect shall be applied.

3.6.2.2 On an instrument with a load receptor having n points of support, with $n > 4$, the fraction $1/(n - 1)$ of the sum of the maximum capacity and the maximum additive tare effect shall be applied to each point of support.

3.6.2.3 On an instrument with a load receptor subject to minimal off-centre loading (e.g. tank, hopper, etc.) a test load corresponding to 1/10 of the sum of the maximum capacity and the maximum additive tare effect shall be applied to each point of support.

3.6.2.4 On an instrument used for weighing rolling loads (e.g. vehicle scale, rail suspension instrument) a test load corresponding to the usual rolling load, the heaviest and the most concentrated one which may be weighed, but not exceeding 0.8 times the sum of the maximum capacity and the maximum additive tare effect, shall be applied at different points on the load receptor.

3.6.3 Multiple indicating devices

For a given load the difference between the indications of multiple indicating devices including tare weighing devices, shall be not greater than the absolute value of the maximum permissible error, but shall be zero between digital displaying and printing devices.

3.6.4 Different positions of equilibrium

The difference between two results obtained for the same load when the method of balancing the load is changed (in the case of an instrument fitted with a device for extending the self-indication capacity) in two consecutive tests, shall not exceed the absolute value of the maximum permissible error for the applied load.

3.7 Test standards

3.7.1 Weights

In principle, the standard weights or standard masses used for the type examination or verification of an instrument shall meet the metrological requirements of OIML R 111. They shall not have an error greater than 1/3 of the maximum permissible error of the instrument for the applied load. If they belong to class E₂ or better, their uncertainty (rather than their error) is allowed to be not greater than 1/3 of the maximum permissible error of the instrument for the applied load, provided that the actual conventional mass and the estimated long-term stability is taken into account.

3.7.2 Auxiliary verification device

When an instrument is fitted with an auxiliary verification device, or when it is verified with a separate auxiliary device, the maximum permissible errors of this device shall be 1/3 of the maximum permissible errors for the applied load. If weights are used, the effect of their errors shall not exceed 1/5 of the maximum permissible errors of the instrument to be verified for the same load.

3.7.3 Substitution of standard weights at verification

When testing instruments at the place of use (application), instead of standard weights any other constant load may be used, provided that standard weights of at least 1/2 Max are used.

If the repeatability error is not greater than 0.3 *e*, the portion of standard weights may be reduced to 1/3 Max.

If the repeatability error is not greater than 0.2 *e*, this portion may be reduced to 1/5 Max.

The repeatability error has to be determined with a load (weights or any other load) of about the value where the substitution is made, by placing it 3 times on the load receptor.

3.8 Discrimination

3.8.1 Non-self-indicating instruments

An extra load equivalent to 0.4 times the absolute value of the maximum permissible error for the applied load, but not less than 1 mg, when gently placed on or withdrawn from the instrument at equilibrium shall produce a visible displacement of the indicating element.

3.8.2 Self- or semi-self-indicating instruments

3.8.2.1 Analog indication

An extra load equivalent to the absolute value of the maximum permissible error for the applied load, but not less than 1 mg, when gently placed on or withdrawn from the instrument at equilibrium shall cause a permanent displacement of the indicating element corresponding to not less than 0.7 times the extra load.

3.8.2.2 Digital indication

An additional load equal to 1.4 times the actual scale interval, when gently placed on or withdrawn from the instrument at equilibrium shall change the indication unambiguously. This applies only to instruments with $d \geq 5$ mg.

3.9 Variations due to influence quantities and time

An instrument shall comply, unless otherwise specified and as far as applicable, with 3.5, 3.6 and 3.8 under the conditions of 3.9. Tests shall not be combined unless otherwise specified,.

3.9.1 Tilting

3.9.1.1 Instruments liable to be tilted

For an instrument of class II, III or IIII liable to be tilted, the influence of tilting shall be determined under the effect of a lengthwise tilting and a transverse tilting equal to the limiting value of tilting as defined in a) to d) below.

The absolute value of the difference between the indication of the instrument in its reference position (not tilted) and the indication in the tilted position (= limiting value of tilting in any direction) shall not exceed:

- at no load, two verification scale intervals (the instrument having first been adjusted to zero at no load in its reference position) except instruments of class II; and
 - at self indication capacity and at maximum capacity, the maximum permissible error (the instrument having been adjusted to zero at no load both in the reference and in the tilted position).
- a) If the instrument is fitted with a leveling device and a level indicator, the limiting value of tilting shall be defined by a marking (e.g. a ring) on the level indicator which shows that the maximum permissible tilt has been exceeded when the bubble is displaced from a central position and the edge touches the marking. The limiting value of the level indicator shall be obvious, so that tilting is easily noticed. The level indicator shall be fixed firmly on the instrument in a place clearly visible to the user and representative for the tilt sensitive part.
- Note:* If, in exceptional circumstances, technical reasons forbid the level indicator to be fixed in a visible place this can be accepted only if the level indicator is easily accessible to the user without tools (e.g. below the removable load receptor), and if there is a legible notice provided on the instrument in a clearly visible place that points the user to the level indicator.
- b) If the instrument is fitted with an automatic tilt sensor the limiting value of tilting is defined by the manufacturer. The tilt sensor shall release a display switch-off or other appropriate alarm signal (e.g. lamp, error signal) and shall inhibit the printout and data transmission if the limiting value of tilting has been exceeded (see also 4.18). The automatic tilt sensor may also compensate the effect of tilting.
- c) If neither a) nor b) applies, the limiting value of tilting is 50/1000 in any direction.
- d) Mobile instruments intended to be used outside in open locations (e.g. on roads) shall either be fitted with an automatic tilt sensor or a Cardanic (gimbal type) suspension of the tilt sensitive part(s). In case of an automatic tilt sensor, b) applies, whereas in the case of a Cardanic suspension, c) applies, but the manufacturer may define a limiting value of tilting larger than 50/1000 (see also 4.18).

3.9.1.2 Other instruments

The following instruments are regarded as being not liable to be tilted so that the tilting requirements under 3.9.1.1 do not apply:

- Class I instruments must be fitted with a leveling device and a level indicator but these need not be tested, because these instruments require special environmental and installation conditions and skilled operating staff.
- Instruments installed in a fixed position.
- Freely suspended instruments, for example crane or hanging instruments.

3.9.2 Temperature

3.9.2.1 Prescribed temperature limits

If no particular working temperature is stated in the descriptive markings of an instrument, this instrument shall maintain its metrological properties within the following temperature limits:

$$- 10 \text{ }^{\circ}\text{C} / + 40 \text{ }^{\circ}\text{C}$$

3.9.2.2 Special temperature limits

An instrument for which particular limits of working temperature are stated in the descriptive markings shall comply with the metrological requirements within those limits.

The limits may be chosen according to the application of the instrument.

The ranges within those limits shall be at least equal to:

- 5 °C for instruments of class I;
- 15 °C for instruments of class II; and
- 30 °C for instruments of classes III and IIII.

3.9.2.3 Temperature effect on no-load indication

The indication at zero or near zero shall not vary by more than one verification scale interval for a difference in ambient temperature of 1 °C for instruments of class I and 5 °C for other classes.

For multi-interval instruments and for multiple range instruments this applies to the smallest verification scale interval of the instrument.

3.9.3 Power supply

An instrument shall comply with the metrological requirements, if the voltage of the power supply differs from the nominal voltage, U_{nom} , or from the voltage range, U_{min} , U_{max} , of the instrument, at:

- Public mains power (AC):
lower limit = $0.85 U_{\text{nom}}$ or $0.85 U_{\text{min}}$
upper limit = $1.10 U_{\text{nom}}$ or $1.10 U_{\text{max}}$
- External or plug-in power supply device (AC or DC), including rechargeable battery power supply if (re)charge of batteries during the operation of the instrument is possible:
lower limit = minimum operating voltage
upper limit = $1.20 U_{\text{nom}}$ or $1.20 U_{\text{max}}$
- Non-rechargeable battery power supply (DC), including rechargeable battery power supply if (re)charge of batteries during the operation of the instrument is not possible:
lower limit = minimum operating voltage
upper limit = U_{nom} or U_{max}
- 12 V or 24 V road vehicle battery power supply:
lower limit = minimum operating voltage
upper limit = 16 V (12 V battery) or 32 V (24 V battery)

Note: The minimum operating voltage is defined as the lowest possible operating voltage before the instrument is automatically switched off.

Battery-powered electronic instruments and instruments with an external or plug-in power supply device (AC or DC) shall either continue to function correctly or not indicate any weight values if the voltage is below the manufacturer's specified value, the latter being larger or equal to the minimum operating voltage.

3.9.4 Time

Under reasonably constant environmental conditions, an instrument of class II, III, or IIII shall meet the following requirements.

3.9.4.1 Creep

When any load is kept on an instrument, the difference between the indication obtained immediately after placing a load and the indication observed during the following 30 minutes, shall not exceed $0.5 e$. However, the difference between the indication obtained at 15 minutes and that at 30 minutes shall not exceed $0.2 e$.

If these conditions are not met, the difference between the indication obtained immediately after placing a load on the instrument and the indication observed during the following four hours shall not exceed the absolute value of the maximum permissible error at the load applied.

3.9.4.2 Zero return

The deviation on returning to zero as soon as the indication has stabilized, after the removal of any load which has remained on the instrument for half an hour, shall not exceed $0.5 e$.

For a multi-interval instrument, the deviation shall not exceed $0.5 e_1$.

On a multiple range instrument, the deviation on returning to zero from Max_i shall not exceed $0.5 e_i$. Furthermore, after returning to zero from any load greater than Max_1 and immediately after switching to the lowest weighing range, the indication near zero shall not vary by more than e_1 during the following 5 minutes.

3.9.4.3 Durability

The durability error due to wear and tear shall not be greater than the absolute value of the maximum permissible error.

Adherence to this requirement is assumed if the instrument has passed the endurance test specified in A.6, which shall be performed only for instruments with $\text{Max} \leq 100 \text{ kg}$.

3.9.5 Other influence quantities and restraints

Where other influences and restraints, such as:

- vibrations;
- precipitations and draughts; and/or
- mechanical constraints and restrictions

are a normal feature of the intended operating environment of the instrument, the instrument shall comply with the requirements of clauses 3 and 4 under those influences and restraints, either by being designed to operate correctly in spite of these influences, or by being protected against their action.

Note: Instruments installed outdoors without suitable protection against atmospheric conditions may normally not comply with the requirements of clauses 3 and 4 if the number of verification scale intervals, n , is relatively great. (In general, a value of $n = 3\,000$ can only be exceeded with very special measures. Furthermore, for road or rail weighbridges the verification scale interval should not be less than 10 kg). These limits should also apply to each weighing range of combinations of instruments or of multiple range instruments or to each partial weighing range of multi-interval instruments.

3.10 Type evaluation tests and examinations

3.10.1 Complete instruments

For type evaluation, the tests given in Annexes A and B shall be performed, to verify adherence to the requirements in 3.5, 3.6, 3.8, 3.9, 4.5, 4.6, 5.3, 5.4 and 6.1. The endurance test (A.6) shall be performed after all the other tests in Annexes A and B.

For software-controlled instruments, the additional requirements in 5.5 and Annex G apply.

3.10.2 Modules

Subject to agreement with the approving authority, the manufacturer may define and submit modules to be examined separately. This is particularly relevant in the following cases:

- where testing the instrument as a whole is difficult or impossible;
- where modules are manufactured and/or placed on the market as separate units to be incorporated in a complete instrument; or
- where the applicant wants to have a variety of modules included in the approved type.

Where modules are examined separately in the process of type approval, the following requirements apply.

3.10.2.1 Apportioning of errors

The error limits applicable to a module, M_i , which is examined separately are equal to a fraction p_i of the maximum permissible errors or the allowed variations of the indication of the complete instrument as specified in 3.5. The fractions for any module have to be taken for at least the same accuracy class and at least the same number of verification scale intervals, as for the complete instrument incorporating the module.

The fractions p_i shall satisfy the following equation:

$$p_1^2 + p_2^2 + p_3^2 + \dots \leq 1$$

The fraction p_i shall be chosen by the manufacturer of the module and shall be verified by an appropriate test, taking into account the following conditions:

- For purely digital devices p_i may be equal to 0.
- For weighing modules p_i may be equal to 1.
- For all other modules (including digital load cells) the fraction shall not exceed 0.8 and shall not be less than 0.3, when more than one module contributes to the effect in question.

Acceptable solution (see explanation in the introductory note to clause 4):

For mechanical structures such as weighbridges, load transmitting devices and mechanical or electrical connecting elements evidently designed and manufactured according to sound engineering practice, an overall fraction $p_i = 0.5$ may be applied without any test, e.g. when levers are made of the same material and when the chain of levers has two planes of symmetry (longitudinal and transversal), or when the stability characteristics of electrical connecting elements are appropriate for the signals transmitted, such as load cell output, impedance, etc.

For instruments incorporating the typical modules (see T.2.2) the fractions p_i may have the values given in Table 7. Table 7 takes into account that the modules are affected in a different manner depending on the different performance criteria.

Table 7

Performance criteria	Load cell	Electronic indicator	Connecting elements, etc.
Combined effect*	0.7	0.5	0.5
Temperature effect on no load indication	0.7	0.5	0.5
Power supply variation	–	1	–
Effect of creep	1	–	–
Damp heat	0.7**	0.5	0.5
Span stability	–	1	–

* Combined effects: non-linearity, hysteresis, temperature effect on span, repeatability, etc. After the warm-up time specified by the manufacturer, the combined effect error fractions apply to modules.

** According to OIML R 60 valid for SH tested load cells ($p_{LC} = 0.7$).

The sign “–” means “not applicable”.

3.10.2.2 Tests

As far as applicable the same tests shall be performed as for complete instruments. The applicable tests for indicators and analog data processing devices are given in Annex C, the applicable tests for digital data processing devices, terminals and digital displays are given in Annex D, and the applicable tests for weighing modules are given in Annex E.

Purely digital modules need not be tested for static temperatures (B.2.1), humidity (B.2.2), and for span stability (B.4). They need not be tested for disturbances (B.3) if conformity to the relevant IEC Standards is otherwise established to at least the same level as required in this Recommendation.

For software-controlled modules the additional requirements in 5.5 and Annex G apply.

3.10.2.3 Compatibility

The compatibility of modules shall be established and declared by the manufacturer. For indicators and load cells this shall be done according to Annex F.

For modules with digital output, compatibility includes the correct communication and data transfer via the digital interface(s), see Annex F.5.

3.10.2.4 Use of OIML Certificates

If a respective OIML Certificate exists, and if the requirements in 3.10.2.1, 3.10.2.2, and 3.10.2.3 are met, the following may be used without repeated testing:

- SH or CH tested load cells (but not NH marked load cells) that have been tested separately according to OIML R 60,;
- indicators and analog data processing devices that have been tested separately according to Annex C;
- digital data processing devices, terminals and digital displays that have been tested separately according to Annex D;
- weighing modules that have been tested separately according to Annex E;
- other modules (if relevant OIML Recommendations exist)

The OIML Certificates must contain all relevant information required in Annex F. OIML Certificates for modules must be clearly distinguishable from OIML Certificates for complete instruments.

A representative complete instrument shall be submitted for testing of correct functioning if this is considered necessary by the responsible authority, e.g. to conduct tests that have not been performed such as tilting.

3.10.3 Peripheral devices

Peripheral recipient devices need to be examined and tested only once while being connected to a weighing instrument, and may be declared as suitable for connection to any verified weighing instrument having an appropriate and protective interface.

Purely digital peripheral devices need not be tested for static temperatures (A.5.3), humidity (B.2), and span stability (B.4). They need not be tested for disturbances (B.3) if conformity to the relevant IEC Standards is otherwise established to at least the same level as required in this Recommendation.

3.10.4 Testing of a family of instruments or modules

Where a family of instruments or modules of various capacities and characteristics is presented for type examination, the following provisions apply for selecting the Equipment Under Test (EUT). For indicators, refer also to Annex C.2.

3.10.4.1 Selection of EUTs

The selection of EUTs to be tested shall be such that their number is minimized but nevertheless sufficiently representative (see example in acceptable solution of 3.10.4.6).

Approval of the most sensitive EUTs implies approval of the variants with lower characteristics. Therefore, when a choice exists, the EUTs with the highest metrological characteristics shall be selected for test.

3.10.4.2 Variants within a family to be tested

For any family, at least the variant with the highest number of verification scale intervals (n) and the variant with the smallest verification scale interval, e , shall be selected as EUTs. Further EUTs may be required according to 3.10.4.6. If a variant has both characteristics, one EUT may be sufficient.

3.10.4.3 Variants acceptable without testing

Variants other than the EUTs can be accepted without testing, if one of the following bulleted provisions is fulfilled (for comparable metrological characteristics):

- Their capacities, Max , fall between two tested capacities. The ratio between the tested capacities shall not exceed 10; or
- All of the following conditions a), b), and c) are fulfilled:
 - a) $n \leq n_{test}$
 - b) $e \geq e_{test}$
 - c) $Max \leq 5 \times Max_{test} \times (n_{test} / n)$

Note: Max_{test} , n_{test} , and e_{test} are the characteristics of the EUT.

3.10.4.4 Accuracy class

If an EUT of a family has been tested completely for one accuracy class, it is sufficient for an EUT of a lower class if only partial tests are carried out that are not yet covered.

3.10.4.5 Other features to be considered

All metrologically relevant features and functions have to be tested at least once in an EUT as far as applicable and as many as possible in the same EUT.

For example, it is not acceptable to test the temperature effect on no-load indication on one EUT and the combined effect (see Table 7) on a different one. Variations in metrologically relevant features and functions such as different:

- housings;
- load receptors;
- temperature and humidity ranges;
- instrument functions;
- indications; etc.

may require additional partial testing of those factors which are influenced by that feature. These additional tests should preferably be carried out on the same EUT, but if this is not possible, tests on one or more additional EUTs may be performed under the responsibility of the testing authority.

3.10.4.6 Summary of relevant metrological characteristics

The EUTs must cover:

- highest number of verification scale intervals, n_{\max} ;
- lowest verification scale interval, e_{\min} ;
- lowest input signal, $\mu\text{V}/e$ (when using analog strain gauge load cells);
- all accuracy classes;
- all temperature ranges;
- single range, multiple range or multi-interval instrument;
- maximum size of load receptor, if significant;
- metrologically relevant features (see 3.10.4.5);
- maximum number of instrument functions;
- maximum number of indications;
- maximum number of peripheral devices connected;
- maximum number of implemented digital devices;
- maximum number of analog and digital interfaces;
- several load receptors, if connectable to the indicator; and
- different types of power supply (mains and/or batteries).

Acceptable solution for the selection of EUTs of a family:

Table 8 – Selection of EUTs for a type of a non-automatic weighing instrument with two families

	Variant	Max	e	d	n	EUT
Family 1 Accuracy class II Temperature range: 10 °C / 30 °C	1.1	200 g	0.01 g	0.001 g	20 000	
	1.2	400 g	0.01 g	0.001 g	40 000	X
	1.3	2000 g	0.05 g	0.05 g	40 000	
Family 2 Accuracy class III Temperature range: – 10 °C / 40 °C	2.1	1.5 kg	0.5 g	0.5 g	3 000	X
	2.2	3 kg	1 g	1 g	3 000	
	2.3	5 kg	2 g	2 g	2 500	
	2.4	15 kg	5 g	5 g	3 000	X
	2.5	60 kg	20 g	20 g	3 000	

Note: This example covers only the various capacities and metrological characteristics of the EUTs according to 3.10.4.2 to 3.10.4.4. The other metrologically relevant features according to 3.10.4.5 must in practice be taken into account, too, and may result in one or more additional EUTs.

Remarks on the selection:

- Variants 1.2, 2.1 and 2.4 are selected as EUTs (marked in last column of Table 8).
- Variant 1.1 needs not be tested, because it has the same e and d as variant 1.2. Only the value of Max is reduced to 200 g (see 3.10.4.3).
- Variant 1.2 has the best metrological characteristics of family 1 and shall be tested completely according to 3.10.4.2.
- Variant 1.3 needs not be tested, because Max is not more than 5 times that for variant 1.2 (see 3.10.4.3).
- Variant 2.1 has the best metrological characteristics of family 2, the smallest e and the greatest n . Therefore variant 2.1 shall be tested (see 3.10.4.4). It is sufficient to perform additionally only the applicable tests for class III. It is not necessary to repeat those tests which are the same for class II and class III and which have already been performed on variant 1.2.
- Variants 2.2 and 2.3 need not be tested, because their values of Max are in between the tested variants 2.1 and 2.4 (see 3.10.4.3) and their metrological characteristics are less than or the same as for variants 2.1 and 2.4.
- Variant 2.4 shall be tested, because the ratio between variant 2.5 and 2.1 is greater than 10 (see 3.10.4.3). For variant 2.4, it is sufficient to perform additionally some important tests such as weighing test, temperature, eccentricity, discrimination, repeatability, etc. It is normally not necessary to repeat other tests (e.g. tilting, power supply, humidity, span stability, endurance, disturbance tests) which have already been performed on variants 1.2 and 2.1.
- Variant 2.5 needs not be tested, because Max is not more than 5 times that for variant 2.4 (see 3.10.4.3).

Table 9 – Summary of the metrological characteristics presented in the OIML Certificate

	Family 1	Family 2
Accuracy class	II	III
Max	1 g ... 2000 g	50 g ... 60 kg
e	0.01 g ... 0.2 g	0.5 g ... 100 g
d	0.001 g ... 0.2 g	0.5 g ... 100 g
n	$\leq 40\ 000$	$\leq 3\ 000$
Tare balancing range	100 % of Max	100 % of Max
Preset tare range	100 % of Max	100 % of Max
Temperature range	10 °C / 30 °C	-10 °C / 40 °C

Note: The respective OIML Certificate shall include either the complete family according to Table 8 with eight instruments in two families or may alternatively include the metrological characteristics of the families according to Table 9. In the latter case the Max values may be reduced (in comparison with the smallest EUT, Table 8) if it is an identical instrument with the same verification scale interval, e , and if the conditions of Table 3 are still met. The Certificate covers all variants that meet the metrological characteristics in Table 9.

4 Technical requirements for self- or semi-self-indicating instruments

The following requirements relate to the design and the construction of instruments, and are intended to ensure that instruments give correct and unambiguous weighing results and other primary indications, under normal conditions of use and proper handling by unskilled users. They are not intended to prescribe solutions, but to define appropriate operation of the instrument.

Certain solutions that have been tried over a long period have become accepted; these solutions are marked “acceptable solution”; while it is not necessary to adopt them, they are considered to comply with the requirements of the applicable provision.

4.1 General construction requirements

4.1.1 Suitability

4.1.1.1 Suitability for application

An instrument shall be designed to suit its intended purpose of use.

Note: “Intended purpose” includes aspects such as the nature and needs of the application and environment. Where the intended purpose needs to be restricted, a marking stating such restriction may be required according to national regulation.

4.1.1.2 Suitability for use

An instrument shall be solidly and carefully constructed in order to ensure that it maintains its metrological qualities during a period of use.

4.1.1.3 Suitability for verification

An instrument shall permit the tests set out in this Recommendation to be performed.

In particular, load receptors shall be such that the standard weight can be deposited on them easily and in total safety. If weights cannot be placed, an additional support may be required.

It must be possible to identify devices that have been subject to a separate type examination procedure (e.g. load cells, printers, etc.).

4.1.2 Security

4.1.2.1 Fraudulent use

An instrument shall have no characteristics likely to facilitate its fraudulent use.

4.1.2.2 Accidental breakdown and maladjustment

An instrument shall be so constructed that an accidental breakdown or a maladjustment of control elements likely to disturb its correct functioning cannot take place without its effect being evident.

4.1.2.3 Controls

Controls shall be so designed that they cannot normally come to rest in positions other than those intended by design, unless during the maneuver all indication is made impossible. Keys shall be marked unambiguously.

4.1.2.4 Securing of components and pre-set controls

Means shall be provided for securing components and pre-set controls to which access or adjustment is prohibited. National legislation may specify the securing that is required.

On a class I instrument, devices to adjust sensitivity (or span) may remain unsecured.

Acceptable solution:

For application of the control marks, the securing area should have a diameter of at least 5 mm.

Components and pre-set controls may be secured by software means provided that any access to the secured controls or functions becomes automatically evident. In addition the following requirements apply to software securing means.

- a) By analogy with conventional securing methods the legal status of the instrument must be recognizable to the user or any other person responsible at the instrument itself.

Securing measures shall provide the evidence of any intervention until the next verification or comparable official inspection.

Acceptable technical solution:

An event counter, i.e. a non-resettable counter that increments each time a protected operational mode of the instrument is entered and one or more changes are made to device-specific parameters. The reference number of the counter at the time of (initial or subsequent) verification is fixed and secured by appropriate hard- or software means at the modified instrument. The actual counter number can be indicated for comparison with the reference number by a procedure described in the manual and in the OIML Certificate and Test Report.

Note: The term “non-resettable” above implies that if the counter has reached its maximum number it will not continue with zero without the intervention of an authorized person.

- b) The device-specific parameter and the reference number shall be protected against unintentional and accidental changes. For these data, the software requirements of 5.5.2.2 shall be met as far as applicable.

Acceptable technical solution:

The device-specific parameter should only be changed by an authorized person via a special PIN-code. The serial number (or other identification) of the instrument as affixed to the instrument's main plate (or other suitable parts) should additionally be stored, if the electronic component or sub-assembly with the memory device is not secured against exchange. These data should be secured by a signature (at least 2 bytes CRC-16 checksum with hidden polynomial), this is considered as a sufficient securing method. The reference number and serial number (respective other identification) should be displayed after manual command and should be compared with the same data affixed and secured on the main plate (or other suitable parts of the instrument).

- c) An instrument making use of a software securing method shall have adequate facilities for affixing the reference number on or near the main plate by an authorized person or body.

Note: A difference between the indicated reference number (according to a)) and the fixed and secured reference number on the instrument indicates an intervention. The consequences are under national legislation (e.g. that the instrument shall no longer be used for legally controlled purposes).

Acceptable technical solution:

Adjustable (hardware) counter that is firmly mounted on the instrument and that can be secured after it has been adjusted to the actual counter number at the time of (initial or subsequent) verification.

4.1.2.5 Adjustment

An instrument may be fitted with an automatic or a semi-automatic span adjustment device. This device shall be incorporated inside the instrument. External influence upon this device shall be practically impossible after securing.

4.1.2.6 Gravity compensation

A gravity sensitive instrument may be equipped with a device for compensating the effects of gravity variations. After securing, external influence on or access to this device shall be practically impossible.

4.2 Indication of weighing results

4.2.1 Quality of reading

Reading of the primary indications (see T.1.3.1) shall be reliable, easy and unambiguous under conditions of normal use:

- the overall inaccuracy of reading of an analog indicating device shall not exceed $0.2 e$; and
- the figures, units and designations forming the primary indications shall be of a size, shape and clarity for reading to be easy.

The scales, numbering and printing shall permit the figures which form the results to be read by simple juxtaposition.

4.2.2 Form of the indication

4.2.2.1 Weighing results and, if applicable, unit price and price to pay shall contain the names or symbols of the units in which they are expressed.

For any one indication of weight, only one unit of mass may be used.

The scale interval for weighing results shall be in the form 1×10^k , 2×10^k or 5×10^k units in which the result is expressed, the index, k , being a positive or negative whole number or equal to zero.

All displaying, printing and tare weighing devices of an instrument shall, within any one weighing range, have the same scale interval for any given load.

4.2.2.2 A digital indication shall show at least one figure beginning at the extreme right.

Where the scale interval is changed automatically the decimal sign shall maintain its position in the display.

A decimal fraction shall be separated from its integer by a decimal sign (comma or dot), with the indication showing at least one figure to the left of the sign and all figures to the right.

The decimal sign shall be aligned with the bottom of the figures (example: 0.305 kg, not 0·305 kg).

Zero may be indicated by one zero to the extreme right, without a decimal sign.

The unit of mass shall be chosen so that weight values have not more than one non-significant zero to the right. For values with decimal sign, the non-significant zero is allowed only in the third position after the decimal sign. For multi-interval instruments and multiple range instruments with automatic change over these requirements apply only to the smallest (partial) weighing range.

Examples for a multi-interval instrument or a multiple range instrument with automatic changeover:

Example 1

Max_i	e_i	Allowed indications			
$\text{Max}_1 = 150 \text{ kg}$	$e_1 = 50 \text{ g}$	xxx.050 kg	xxx.050 kg	xxx.05 kg	xxx.05 kg
$\text{Max}_2 = 300 \text{ kg}$	$e_2 = 100 \text{ g}$	xxx.100 kg	xxx.1 kg	xxx.10 kg	xxx.1 kg

Example 2

Max_i	e_i	Allowed indications
$\text{Max}_1 = 1500 \text{ kg}$	$e_1 = 500 \text{ g}$	xxxx.5 kg
$\text{Max}_2 = 3000 \text{ kg}$	$e_2 = 1000 \text{ g}$	xxx1.0 kg

4.2.3 Limits of indication

There shall be no indication above $\text{Max} + 9 e$.

For multiple range instruments this applies to each weighing range. For multiple range instruments with automatic change over, however, Max is equal to Max_r of the highest weighing range, r , and there shall be no indication above $\text{Max}_i = n \times e_i$ for the smaller weighing range(s), i .

For multi-interval instruments there shall be no indication using e_i above $\text{Max}_i = n_i \times e_i$ for the lower partial weighing range(s), i .

An indication below zero (with minus sign) is possible when a tare device is in operation and the tare load has been removed from the load receptor. It is also possible that negative values down to $-20 d$ are displayed even if there is no tare device in operation, provided these values cannot be transmitted, printed or used for a price calculation.

4.2.4 Approximate displaying device

The scale interval of an approximate displaying device shall be greater than $\text{Max}/100$ without being smaller than $20 e$. This approximate device is considered as giving secondary indications.

4.2.5 Extending the range of self-indication on a semi-self-indicating instrument

The extension interval of the range of self-indication shall not be greater than the value of the self-indication capacity.

Acceptable solutions:

- The scale interval of extension of the range of self-indication should be equal to the capacity of self-indication (comparator instruments are excluded from this provision).
- An extension device with accessible sliding poises is subject to the requirements of 6.2.2.
- On an extension device with enclosed sliding poises or weight switching mechanisms, each extension should involve an adequate change in the numbering. It should be possible to seal the housing and the adjusting cavities of the weights or masses.

4.3 Analog indicating device

The following requirements apply in addition to those in 4.2.1-4.2.4.

4.3.1 Scale marks; length and width

Scales shall be designed and numbered so that reading the weighing result is easy and unambiguous.

Acceptable solutions:

a) Form of scale marks

Scale marks should consist of lines of equal thickness; this thickness should be constant and be between 1/10 and 1/4 of the scale spacing, without being less than 0.2 mm. The length of the shortest scale mark should be at least equal to the scale spacing.

b) Arrangement of scale marks

Scale marks should be arranged in accordance with one of the sketches in Figure 6 (the line joining the end of the scale marks is optional).

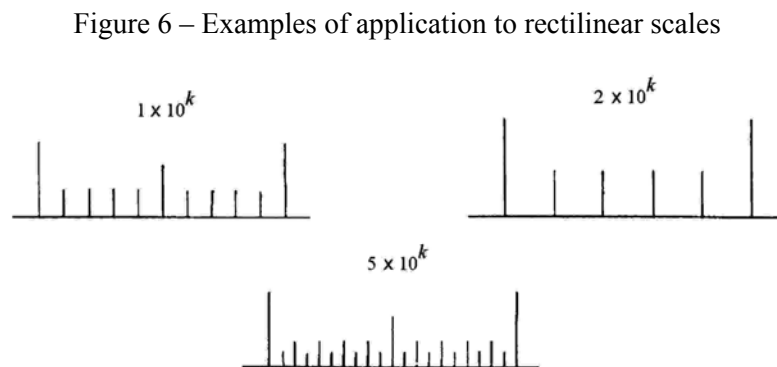

c) Numbering

On one scale, the scale interval used for numbering should be:

- constant,
- in the form 1×10^k , 2×10^k , 5×10^k units (k being a positive or negative whole number or equal to zero),
- not greater than 25 times the scale interval of the instrument.

If the scale is projected on a screen, at least two numbered scale marks should appear wholly in the projected zone.

The height of the numbers (real or apparent) expressed in millimetres should be not less than three times the minimum reading distance expressed in metres, without being less than 2 mm.

This height should be proportional to the length of the scale mark to which it relates.

The width of a number, measured parallel to the base of the scale, should be less than the distance between two consecutive numbered scale marks.

d) Indicating component

The width of the pointer of the displaying component should be approximately equal to that of the scale marks and of a length such that the tip is at least level with the middle of the shortest mark.

The distance between the scale and the pointer should be at most equal to the scale spacing, without being greater than 2 mm.

4.3.2 Scale spacing

The minimum value, i_0 , of the scale spacing is equal to:

- on an instrument of class I or II:
 - 1 mm for indicating devices,
 - 0.25 mm for complementary indicating devices. In this case, i_0 is the relative displacement between the displaying component and the projected scale corresponding to the verification scale interval of the instrument;
- on an instrument of class III or IIII:
 - 1.25 mm for dial indicating devices,
 - 1.75 mm for optical projection indicating devices.

Acceptable solution:

The scale spacing (real or apparent), i , in millimetres, should be at least equal to:

$$(L + 0.5) i_0,$$

where: i_0 = minimum scale spacing in millimetres,

L = minimum reading distance in metres; $L \geq 0.5$ m

The greatest scale spacing should not exceed 1.2 times the smallest scale spacing of the same scale.

4.3.3 Limits of indication

Stops shall limit the movement of the displaying component whilst allowing it to travel below zero and above the capacity of self-indication. This requirement does not apply to multi-revolution dial instruments.

Acceptable solution:

The stops limiting the movement of the displaying component should permit it to travel across zones of at least four scale spacings below zero and above the capacity of self-indication (these zones are not provided with a scale on fan charts and on dials with a single revolution pointer; they are called “blank zones”).

4.3.4 Damping

The damping of the oscillations of the displaying component or of the movable scale shall be adjusted to a value slightly below “critical damping”, whatever the influence factors.

Acceptable solution:

Damping should achieve a stable indication after three, four or five half periods of oscillation.

Hydraulic damping elements sensitive to variations in temperature should be provided with a automatic regulating device or an easily accessible manual regulating device.

It should be impossible for the fluid of hydraulic damping elements on portable instruments to spill when the instrument is inclined at 45°.

4.4 Digital indicating devices

The following requirements apply in addition to those in 4.2.1 through 4.2.5.

4.4.1 Change of indication

After a change in load, the previous indication shall not persist for longer than 1 second.

4.4.2 Stable equilibrium

An indication is defined as being in stable equilibrium if it is sufficiently close to the final weight value. Stable equilibrium is considered to be achieved if:

- in the case of printing and/or data storage, the printed or stored weight values do not deviate more than $1 e$ from the final weight value (i.e. two adjacent values are allowed); or
- in the case of zero or tare operations, correct operation of the device according to 4.5.4, 4.5.6, 4.5.7 and 4.6.8 within relevant accuracy requirements is achieved.

During continuous or temporary disturbance of the equilibrium, the instrument shall not print, store data, or set zero, or tare.

4.4.3 Extended indicating devices

An extended indicating device shall not be used on an instrument with a differentiated scale division.

When an instrument is fitted with an extended indicating device, displaying the indication with a scale interval smaller than e shall be possible only:

- during pressing a key; or
- for a period not exceeding 5 seconds after a manual command.

In any case printing shall not be possible while the extended indicating device is in operation.

4.4.4 Multiple use of indicating devices

Indications other than primary indications may be displayed or printed in the same indicating device, provided that:

- any additional indications do not lead to any ambiguity in regard to the primary indications;
- quantities other than weight values are identified by the appropriate unit of measurement, or symbol thereof, or a special sign or designation; and
- weight values that are not weighing results (T.5.2.1-T.5.2.3) shall be clearly identified. Otherwise they may be displayed only temporarily on manual command and shall not be printed.

No restrictions apply if the weighing mode is made inoperative and this is clear and unambiguous (also for customers in the case of instruments used for direct sales).

4.4.5 Printing devices

Printing shall be clear and permanent for the intended use. Printed figures shall be at least 2 mm high.

If printing takes place, the name or the symbol of the unit of measurement shall be either to the right of the value or above a column of values.

Printing shall be inhibited when the equilibrium is not stable.

4.4.6 Memory storage devices

The storage of primary indications for subsequent indication, data transfer, totalizing, etc. shall be inhibited when the equilibrium is not stable.

4.5 Zero-setting and zero-tracking devices

An instrument may have one or more zero-setting devices and shall have not more than one zero-tracking device.

4.5.1 Maximum effect

The effect of any zero-setting device shall not alter the maximum weighing capacity of the instrument.

The overall effect of zero-setting and zero-tracking devices shall be not more than 4 %, and of the initial zero-setting device not more than 20 %, of the maximum capacity. This does not affect an instrument of class III, except if it is used for commercial transactions.

A wider range is possible for the initial zero-setting device if the instrument complies with 3.5, 3.6, 3.8 and 3.9 for any load compensated by this device within the specified range.

4.5.2 Accuracy

After zero setting the effect of zero deviation on the result of the weighing shall be not more than $\pm 0.25 e$.

4.5.3 Multiple range instruments

Zero setting in any weighing range shall be effective also in the greater weighing ranges, if switching to a greater weighing range is possible while the instrument is loaded.

4.5.4 Control of the zero-setting device

An instrument - except an instrument according to 4.13 and 4.14 - whether or not equipped with an initial zero-setting device, may have a combined semi-automatic zero-setting and semi-automatic tare-balancing device operated by the same key.

If an instrument has a zero-setting device and a tare-weighing device the control of the zero-setting device shall be separate from that of the tare-weighing device.

A semi-automatic zero-setting device shall function only:

- when the instrument is in stable equilibrium; and
- it cancels any previous tare operation.

4.5.5 Zero indicating devices on an instrument with digital indication

An instrument with digital indication shall have a device that displays a special signal when the deviation from zero is not more than $\pm 0.25 e$. This device may also work when zero is indicated after a tare operation.

This device is not mandatory on an instrument that has an auxiliary indicating or a zero-tracking device provided that the rate of zero-tracking is not less than $0.25 d/\text{second}$.

4.5.6 Automatic zero-setting devices

An automatic zero-setting device shall operate only when:

- the equilibrium is stable; and
- the indication has remained stable below zero for at least 5 seconds.

4.5.7 Zero-tracking devices

A zero-tracking device shall operate only when:

- the indication is at zero, or at a negative net value equivalent to gross zero;
- the equilibrium is stable; and
- the corrections are not more than $0.5 d/\text{second}$.

When zero is indicated after a tare operation, the zero-tracking device may operate within a range of 4 % of Max around the actual zero value.

4.6 Tare devices

4.6.1 General requirements

A tare device shall comply with the relevant provisions of 4.1-4.4.

4.6.2 Scale interval

The scale interval of a tare-weighing device shall be equal to the scale interval of the instrument for any given load.

4.6.3 Accuracy

A tare device shall permit setting the indication to zero with an accuracy better than:

- $\pm 0.25 e$ for electronic instruments and any instrument with analog indication; or
- $\pm 0.5 d$ for mechanical instruments with digital indication.

On a multi-interval instrument e shall be replaced by e_1 .

4.6.4 Operating range

The tare device shall be such that it cannot be used at or below its zero effect or above its maximum indicated effect.

4.6.5 Visibility of operation

Operation of the tare device shall be visibly indicated on the instrument. In the case of instruments with digital indication this shall be done by marking the indicated net value with the sign “NET”.

Note 1: “NET” may alternatively be displayed as “Net” or “net”.

Note 2: If an instrument is equipped with a device that allows the gross value to be displayed temporarily while a tare device is in operation, the “NET” symbol shall disappear while the gross value is displayed.

This is not required for an instrument with a combined semi-automatic zero-setting device and a semi-automatic tare-balancing device operated by the same key.

It is permitted to replace “NET” by complete words in an official language of the country in which the instrument is used.

Acceptable solution:

The use of a mechanical tare adding device should be shown by the indication of the tare value, or by the display on the instrument of a sign, e.g. the letter “T”.

4.6.6 Subtractive tare devices

When the use of a subtractive tare device does not allow the value of the residual weighing range to be known, a device shall prevent the use of the instrument above its maximum capacity or indicate that this capacity has been reached.

4.6.7 Multiple range instruments

On a multiple range instrument the tare operation shall be effective also in the greater weighing ranges, if switching to a greater weighing range is possible while the instrument is loaded. In that case

the tare weight values shall be rounded to the scale interval of the actual weighing range which is in operation.

4.6.8 Semi-automatic or automatic tare devices

These devices shall operate only when the instrument is in stable equilibrium.

4.6.9 Combined zero-setting and tare-balancing devices

If the semi-automatic zero-setting device and the semi-automatic tare-balancing device are operated by the same key, 4.5.2, 4.5.5 and if appropriate 4.5.7 apply at any load.

4.6.10 Consecutive tare operations

Repeated operation of a tare device is permitted.

If more than one tare device is operative at the same time, tare values shall be clearly designated when indicated or printed.

4.6.11 Printing of weighing results

Gross weight values may be printed without any designation. For a designation by a symbol, only “G” or “B” are permitted.

If only net weight values are printed without corresponding gross or tare values, they may be printed without any designation. A symbol for designation shall be “N”. This applies also where semi-automatic zero setting and semi-automatic tare balancing are initiated by the same key.

Gross, net, or tare values determined by a multiple range instrument or by a multi-interval instrument need not be marked by a special designation referring to the (partial) weighing range.

If net weight values are printed together with the corresponding gross and/or tare values, the net and tare values shall at least be identified by the corresponding symbols “N” and “T”.

However, it is permitted to replace “G”, “B”, “N” and “T” by complete words in an official language of the country where the instrument is used.

If net weight values and tare values determined by different tare devices are printed separately, they shall be suitably identified.

When gross, net and tare values are printed together, one of these values may be calculated from two actual determinations of mass. In the case of a multi-interval instrument the calculated weight value may be printed with a smaller scale interval.

The printout of a calculated weight value shall be clearly identified. This should preferably be done by the symbol “C” in addition to the symbol mentioned above if applicable or by complete words in an official language of the country where the instrument is used.

4.6.12 Examples of indications of weighing results

4.6.12.1 Instrument with a tare-balancing device

Specifications of the instrument: Class III, Max = 15 kg, $e = 5$ g

Unloaded instrument	displayed value = 0.000 kg
Loading with tare load, internal value = 2.728 kg, After releasing tare-balancing	rounded and displayed value = 2.730 kg ¹⁾ displayed net value = 0.000 kg Net
Loading with net load, internal value = 11.833 kg,	rounded and displayed net value = 11.835 kg Net ¹⁾
Total loading, internal value = 14.561 kg,	rounded and displayed (if possible) gross value = 14.560 kg ¹⁾

Possible printouts according to 4.6.11:

- | | |
|-----------------------|-------------|
| a) 14.560 kg B (or G) | 11.835 kg N |
| b) 14.560 kg | 11.835 kg N |
| c) 11.835 kg N | |
| d) 11.835 kg | |

4.6.12.2 Instrument with a tare-weighing device

Specifications of the instrument: Class III Max = 15 kg, $e = 5$ g

Unloaded instrument	displayed value = 0.000 kg
Loading with tare load, internal value = 2.728 kg, After releasing tare-weighing,	rounded and displayed value = 2.730 kg ¹⁾ displayed net value = 0.000 kg Net
Loading with net load, internal value = 11.833 kg,	rounded and displayed net value = 11.835 kg Net ¹⁾
Total loading, internal value = 14.561 kg,	rounded and displayed (if possible) gross value = 14.560 kg ¹⁾

Possible printouts according to 4.6.11:

- | | | |
|-----------------------|-------------|--------------------------|
| a) 14.560 kg B (or G) | 11.835 kg N | 2.730 kg T ⁴⁾ |
| b) 14.560 kg | 11.835 kg N | 2.730 kg T ⁴⁾ |
| c) 11.835 kg N | 2.730 kg T | |
| d) 11.835 kg N | | |
| e) 11.835 kg | | |

4.6.12.3 Multiple range instrument with a tare-weighing device

Specifications of the instrument: Class III, Max₁ = 60 kg, $e_1 = 10$ g, Max₂ = 300 kg, $e_2 = 100$ g

Unloaded instrument,	displayed value in weighing range (WR) 1 = WR1	0.000 kg
Loading with tare load, internal value = 53.466 kg, After releasing tare-weighing,	rounded and displayed value = WR1	53.470 kg ¹⁾
Loading with net load, internal value = 212.753 kg,	displayed net value = WR1	0.000 kg Net
	rounded and displayed net value = WR2	212.800 kg Net ¹⁾²⁾
With automatic change over to weighing range 2, the tare-weighing value shall be rounded to the actual e of weighing range 2,	rounded tare-weighing value = WR2	53.500 kg ²⁾³⁾
Total loading, internal value = 266.219 kg	rounded & displayed (if possible) gross value = WR2	266.200 kg ¹⁾²⁾

Possible printouts according to 4.6.11:

- | | | |
|-------------------------------|---------------------------|-----------------------------|
| a) 266.200 kg B (or G) | 212.800 kg N | 53.500 kg T ²⁾⁴⁾ |
| b) 266.200 kg | 212.800 kg N | 53.500 kg T ²⁾⁴⁾ |
| c) 212.800 kg N | 53.500 kg T ²⁾ | |
| d) 212.800 kg N ²⁾ | | |
| e) 212.800 kg ²⁾ | | |

4.6.12.4 Multi-interval instrument with a tare-weighing device

Specifications of the instrument: Class III, Max = 3/6/15 t, $e = 0.5/2/10$ kg

Unloaded instrument	displayed value = 0.0 kg
Loading with tare load, internal value = 6674 kg, After releasing tare-weighing	rounded and displayed value = 6670.0 kg ¹⁾ displayed net value = 0.0 kg Net
Loading with net load, internal value = 2673.7 kg,	rounded and displayed net value = 2673.5 kg Net ¹⁾
Total loading, internal value = 9347.7 kg,	rounded and displayed (if possible) gross value = 9350.0 kg ¹⁾²⁾

Possible printouts according to 4.6.11:

- | | | |
|------------------------------|---------------------------|-----------------------------|
| a) 9350.0 kg B (or G) | 2673.5 kg N | 6670.0 kg T ²⁾⁴⁾ |
| b) 9350.0 kg | 2673.5 kg N | 6670.0 kg T ²⁾⁴⁾ |
| c) 2673.5 kg N | 6670.0 kg T ²⁾ | |
| d) 2673.5 kg N ²⁾ | | |
| e) 2673.5 kg ²⁾ | | |

4.6.12.5 Multi-interval instrument with a preset tare device (4.7)Specifications of the instrument: Class III, Max = 4/10/20 kg, $e = 2/5/10$ g

Unloaded instrument	displayed value = 0.000 kg
Loading with gross load, internal value = 13.376 kg, Input of the preset tare value = 3.813 kg,	rounded and displayed gross value = 13.380 kg ¹⁾ displayed value during input = 3.813 kg rounded and temporarily displayed preset tare value = 3.814 kg PT

the tare value may be rounded up or down,
because $e = 2$ g (or 3.812 kg PT)

internal calculation: 13.380 kg – 3.814 kg = 9.566 kg, rounded and displayed net value = 9.565 kg Net⁵⁾
or: 13.380 kg – 3.812 kg = 9.568 kg, rounded and displayed net value = 9.570 kg Net⁵⁾

Possible printouts according to 4.6.11 and 4.7.3:

a) 13.380 kg B (or G)	9.565 kg N	3.814 kg PT ⁴⁾
b) 13.380 kg	9.565 kg N	3.814 kg PT ⁴⁾
c) 9.565 kg N	3.814 kg PT	

or:

a) 13.380 kg B (or G)	9.570 kg N	3.812 kg PT ⁴⁾
b) 13.380 kg	9.570 kg N	3.812 kg PT ⁴⁾
c) 9.570 kg N	3.812 kg PT	

4.6.12.6 Multi-interval instrument with a calculated weight valueSpecifications of the instrument: Class III, Max = 20/50/150 kg, $e = 10/20/100$ g

Unloaded instrument	displayed value = 0.000 kg
First weighing (empty container, tare value) = 17.726 kg	displayed value = 17.730 kg
Unloaded instrument	displayed value = 0.000 kg
Second weighing (net load, net value) = 126.15 kg,	rounded and displayed value = 126.200 kg

Possible printouts according to 4.6.11:

Gross 143.930 kg C	Tare 17.730 kg	Net 126.200 kg
--------------------	----------------	----------------

Footnotes:

- ¹⁾ The maximum permissible errors are applicable to weighing results of gross (3.5.1), tare (3.5.3.4) and net (3.5.3.3) with the exception of calculated net weights because of a preset tare (3.5.3.3).
- ²⁾ On multi-interval and on multiple range instruments with automatic changeover in the higher (partial) weighing ranges more than one non-significant zeros may appear, depending on the smallest (partial) weighing range (4.2.2.2).
- ³⁾ On multiple range instruments the tare values shall be rounded to the scale interval of the actual weighing range which is in operation (4.6.7, 4.7.1).
- ⁴⁾ The displayed and printed weighing results (gross, tare weighing, net) shall be rounded each to the actual e . The e can be different depending on the actual weighing range or the actual partial weighing range, so a deviation of $1 \times e$ may be possible between the gross weighing result and the calculation of net and tare values.

Consistent results are only possible according to paragraph 7 and 8 of 4.6.11 (see 4.6.12.6).

- ⁵⁾ The calculated net value is calculated from the displayed gross weight value and from the displayed and already rounded preset tare value (T.5.3.2), not from the internal values.

4.7 Preset tare devices

4.7.1 Scale interval

Regardless of how a preset tare value is introduced into the device, its scale interval shall be equal or automatically rounded to the scale interval of the instrument. On a multiple range instrument a preset tare value may only be transferred from one weighing range to another one with a larger verification scale interval but shall then be rounded to the latter. For a multi-interval instrument, the preset tare value shall be rounded to the smallest verification scale interval, e_1 , of the instrument, and the maximum preset tare value shall not be greater than Max_1 . The displayed or printed calculated net value shall be rounded to the scale interval of the instrument for the same net weight value.

4.7.2 Modes of operation

A preset tare device may be operated together with one or more tare devices provided that:

- 4.6.10 is respected; and
- a preset tare operation cannot be modified or cancelled as long as any tare device operated after the preset tare operation is still in use.

Preset tare devices may operate automatically only if the preset tare value is clearly identified with the load to be measured (e.g. by bar code identification on the container of the load to be weighed).

4.7.3 Indication of operation

Operation of the preset tare device shall be visibly indicated on the instrument. In the case of instruments with digital indication this shall be done by marking the indicated net value with “NET”, “Net” or “net” or by complete words in an official language of the country in which the instrument is used. If an instrument is equipped with a device that allows the gross value to be displayed temporarily while a tare device is in operation, the “NET” symbol shall disappear while the gross value is displayed.

It shall be possible to indicate the preset tare value at least temporarily.

4.6.11 applies accordingly provided that:

- if the calculated net value is printed, at least the preset tare value is printed as well, with the exception of an instrument covered by 4.13, 4.14 or 4.16; and
- preset tare values are designated by the symbol “PT”. However, it is permitted to replace the symbol “PT” by complete words in an official language of the country in which the instrument is used.

Note: 4.7.3 also applies to instruments with a combined semi-automatic zero-setting device and a semi-automatic tare-balancing device operated by the same key.

4.8 Locking positions

4.8.1 Prevention of weighing outside the “weigh” position

If an instrument has one or more locking devices, these devices shall only have two stable positions corresponding to “locked” and “weigh” and weighing shall only be possible in the “weigh” position.

A “preweigh” position may exist on an instrument of class I or II except those under 4.13, 4.14 and 4.16.

4.8.2 Indication of position

The “locked” and “weigh” positions shall be clearly shown.

4.9 Auxiliary verification devices (removable or fixed)

4.9.1 Devices with one or more platform(s)

The nominal value of the ratio between the weights to be placed on the platform to balance a certain load and this load shall not be less than 1/5000 (it shall be visibly indicated just above the platform).

The value of the weights needed to balance a load equal to the verification scale interval shall be an integer multiple of 0.1 g.

4.9.2 Numbered scale devices

The scale interval of the auxiliary verification device shall be equal to or smaller than 1/5 of the verification scale interval for which it is intended.

4.10 Selection of weighing ranges on a multiple range instrument

The range which is actually in operation shall be clearly indicated. Manual selection of the weighing range is allowed:

- from a smaller to a greater weighing range, at any load; and
- from a greater to a smaller weighing range, when there is no load on the load receptor, and the indication is zero or at a negative net value equivalent to gross zero; the tare operation shall be cancelled, and zero shall be set to $\pm 0.25 e_1$, both automatically.

Automatic change-over is allowed:

- from a smaller to the following greater weighing range when the load exceeds the maximum gross weight Max_i of the range, i , of the range being operative; and
- only from a greater to the smallest weighing range when there is no load on the load receptor, and the indication is zero or at a negative net value equivalent to gross zero. The tare operation shall be cancelled and zero shall be set to $\pm 0.25 e_1$, both automatically.

4.11 Devices for selection (or switching) between various load receptors and/or load transmitting devices and various load measuring devices

4.11.1 Compensation of no-load effect

The selection device shall ensure compensation for the unequal no-load effect of the various load receptors and/or load transmitting devices in use.

4.11.2 Zero-setting

Zero-setting of an instrument with any multiple combination of various load measuring devices and various load receptors shall be possible without ambiguity and in accordance with the provisions of 4.5.

4.11.3 Impossibility of weighing

Weighing shall not be possible while selection devices are being used.

4.11.4 Identification of the combinations used

Combinations of load receptors and load measuring devices used shall be readily identifiable.

It shall be clearly visible which indication(s) correspond to which load receptor(s).

4.12 “Plus and minus” comparator instruments

For the purposes of verification, a “plus and minus” comparator instrument is considered to be a semi-self-indicating instrument.

4.12.1 Distinction between “plus” and “minus” zones

On an analog indicating device the zones situated on either side of zero shall be distinguished by “+” and “-” signs.

On a digital indicating device an inscription near the indicating device shall be given:

- range $\pm \dots u_m$; or
- range $- \dots u_m / + \dots u_m$

where u_m represents the unit of measurement according to 2.1.

4.12.2 Form of scale

The scale of a comparator instrument shall have at least one scale division, $d = e$, on either side of zero. The corresponding value shall be shown at either end of the scale.

4.13 Instruments for direct sales to the public

Note: Interpretation of what is included in “direct sales to the public” is left up to national legislation.

The following requirements apply to an instrument of class II, III or IIII with a maximum capacity not greater than 100 kg designed to be used for direct sales to the public, in addition to the requirements of 4.1 to 4.11 and 4.20.

4.13.1 Primary indications

On an instrument for direct sales to the public the primary indications are the weighing result and information about correct zero position, tare and preset tare operations.

4.13.2 Zero-setting devices

An instrument for direct sales to the public shall not be fitted with a non-automatic zero-setting device unless operated only with a tool.

4.13.3 Tare devices

A mechanical instrument with a weight receptor shall not be fitted with a tare device.

An instrument with one platform may be fitted with tare devices if they allow the public to see:

- whether they are in use; and
- whether their setting is altered.

Only one tare device shall be in operation at any given time.

Note: The restrictions in use are included under 4.13.3.2, 2nd indent.

An instrument shall not be fitted with a device which can recall the gross value while a tare or preset tare device is in operation.

4.13.3.1 Non-automatic tare devices

A displacement of 5 mm of a point of the control shall be at most equal to one verification scale interval.

4.13.3.2 Semi-automatic tare devices

An instrument may be fitted with semi-automatic tare devices if:

- the action of the tare devices does not permit a reduction of the value of the tare; and
- their effect can only be cancelled when there is no load on the load receptor.

In addition, the instrument shall comply with at least one of the following requirements:

- the tare value is indicated permanently in a separate display;
- the tare value is indicated with a “-” sign when there is no load on the load receptor; or
- the effect of the device is cancelled automatically and the indication returns to zero when unloading the load receptor after a stable net weighing result greater than zero has been indicated.

4.13.3.3 Automatic tare devices

An instrument shall not be fitted with an automatic tare device.

4.13.4 Preset tare devices

A preset tare device may be provided if the preset tare value is indicated as a primary indication on a separate display which is clearly differentiated from the weight display. The first paragraph of 4.13.3.2 applies.

It shall not be possible to operate a preset tare device if a tare device is in use.

Where a preset tare is associated with a price look up (PLU) the preset tare value should be cancelled at the same time as the PLU is cancelled.

4.13.5 Impossibility of weighing

It shall be impossible to weigh or to guide the indicating element during the normal locking operation or during the normal operation of adding or subtracting weights.

4.13.6 Visibility

All primary indications (4.13.1, and 4.14.1 if applicable) shall be indicated clearly and simultaneously to both the vendor and the customer. If this is not possible with one display device two sets are necessary, one set each for the vendor and the customer.

On digital devices that display primary indications, the numerical figures displayed to the customer shall be at least 9.5 mm high.

On an instrument to be used with weights it shall be possible to distinguish the value of the weights.

4.13.7 Auxiliary and extended indicating devices

An instrument shall not be fitted with an auxiliary indicating device nor an extended indicating device.

4.13.8 Instruments of class II

An instrument of class II shall comply with the requirements given in 3.9 for an instrument of class III.

4.13.9 Significant fault

When a significant fault has been detected, a visible or audible alarm shall be provided for the customer, and data transmission to any peripheral equipment shall be prevented. This alarm shall continue until such time as the user takes action or the cause disappears.

4.13.10 Counting ratio

The counting ratio on a mechanical counting instrument shall be 1/10 or 1/100.

4.13.11 Self-service instruments

A self-service instrument need not have two sets of scales or displays.

If a ticket or a label is printed, the primary indications shall include a designation of the product when the instrument is used to sell different products.

If a price-computing instrument is used as a self-service instrument then the requirements in 4.14 must be met.

4.14 Additional requirements for price-computing instruments for direct sales to the public

The following requirements are to be applied in addition to 4.13.

4.14.1 Primary indications

On a price-indicating instrument the supplementary primary indications are unit price and price to pay and, if applicable, number, unit price and price to pay for non-weighed articles, prices for non-weighed articles and price totals. Price charts (as opposed to price scales, which are covered by 4.14.2), such as fan charts, are not subject to the requirements of this Recommendation.

4.14.2 Instruments with price scales

For unit price and price-to-pay scales, 4.2 and 4.3.1-4.3.3 apply accordingly; however, decimal fractions shall be indicated according to national regulations.

It shall be possible to read price scales such that the absolute value of the difference between the product of the indicated weight value, W , and the unit price, U , and the indicated price to pay, P , is not greater than the product of e and the unit price for that scale:

$$|W \times U - P| \leq e \times U$$

4.14.3 Price computing instruments

The price to pay shall be calculated and rounded to the nearest interval of price to pay, by multiplication of weight value and unit price, both as indicated by the instrument. The device or devices which perform the calculation and indication of the price to pay are in any case considered part of the instrument.

The interval of price to pay shall comply with the national regulations applicable to trade.

The unit price is restricted to price/100 g or price/kg.

Notwithstanding the provision in 4.4.1:

- the indications of weight value, unit price and price to pay shall remain visible after the weight indication is stable, and after any introduction of the unit price, for at least one second and while the load is on the load receptor; and
- these indications may remain visible for no more than 3 seconds after removing the load, provided that the weight indication has been stable before and the indication would otherwise be zero. As long as there is a weight indication after removing the load, it shall not be possible to introduce or change a unit price.

If transactions performed by the instrument are printed, weight value, unit price and price to pay shall all be printed.

The data may be stored in a memory of the instrument before printing. The same data shall not be printed twice on the ticket for the customer.

Instruments that can be used for price labeling purposes must also comply with 4.16.

4.14.4 Special applications of price computing instruments

Only if all transactions performed by the instrument or by connected peripherals are printed on a ticket or label intended for the customer, a price computing instrument may perform additional functions which facilitate trade and management. These functions shall not lead to confusion about the results of weighing and price computing.

Other operations or indications not covered by the following provisions may be performed, provided that no indication which could possibly be misunderstood as a primary indication is presented to the customer.

4.14.4.1 Non-weighed articles

An instrument may accept and record positive or negative prices to pay of one or several non-weighed articles, provided that the weight indication is zero or the weighing mode is made inoperative. The price to pay for one or more of such articles shall be shown in the price-to-pay display.

If the price to pay is calculated for more than one equal articles, the number of articles shall be shown on the weight display, without being possibly taken for a weight value, and the price for one article on the unit price display, unless supplementary displays are used to show the number of articles and the article price.

Acceptable solution:

A number of articles shown on the weight display is distinguished from a weight value by including an appropriate designation such as “X” or other clear designation in accordance with national regulations (if any).

4.14.4.2 Totalization

An instrument may totalize transactions on one or several tickets; the price total shall be indicated on the price-to-pay display, and printed accompanied by a special word or symbol, either at the end of the price-to-pay column, or on a separate label or ticket with appropriate reference to the commodities whose prices to pay have been totalized; all prices to pay that are totalized shall be printed, and the price total shall be the algebraic sum of all these prices as printed.

An instrument may totalize transactions performed on other instruments linked to it, directly or over metrologically controlled peripherals, under the provisions of 4.14.4 and if the price-to-pay scale intervals of all connected instruments are identical.

4.14.4.3 Multi-vendor operation

An instrument may be designed to be used by more than one vendor or to serve more than one customer at the same time, provided that the connection between the transactions and the relevant vendor or customer is appropriately identified (refer to 4.14.4).

4.14.4.4 Cancellation

An instrument may cancel previous transactions. Where the transaction has already been printed, the relevant price to pay cancelled shall be printed with an appropriate comment. If the transaction to be cancelled is displayed to the customer it shall be clearly differentiated from normal transactions.

4.14.4.5 Additional information

An instrument may print additional information if this is clearly correlated to the transaction and does not interfere with the assignment of the weight value to the unit symbol.

4.15 Instruments similar to those normally used for direct sales to the public

An instrument similar to one normally used for direct sales to the public which does not comply with the provisions of 4.13 and 4.14 shall carry, near the display, the indelible marking “Not to be used for direct sales to the public”

4.16 Price-labeling instruments

4.13.8, 4.14.3 (paragraphs 1 and 5), 4.14.4.1 (paragraph 1) and 4.14.4.5 apply.

A price-labeling instrument shall have at least one display for the weight value. It may be used temporarily for set-up purposes such as supervision of setting weight limits, unit prices, preset tare values, commodity names.

It shall be possible to verify, during use of the instrument, the actual values of unit price and preset tare value.

Printing below minimum capacity shall not be possible.

Printing of labels with fixed values of weight, unit price and price to pay is allowed provided that the weighing mode is obviously made inoperative.

4.17 Mechanical counting instruments with unit-weight receptor

For the purpose of verification a counting instrument is considered to be a semi-self-indicating instrument.

4.17.1 Indicating devices

To permit verification, a counting instrument shall have a scale with at least one scale division, $d = e$, on either side of zero; the corresponding value shall be shown on the scale.

4.17.2 Counting ratio

The counting ratio shall be shown clearly just above each counting platform or each counting scale mark.

4.18 Additional technical requirements for mobile instruments (see also 3.9.1.1)

Depending on the type of mobile instrument the following characteristics shall be defined by the applicant:

- warm-up procedure/period (in addition to 5.3.5) of the hydraulic lifting system when a hydraulic system is involved in the weighing process;
- the limiting value of tilting (upper limit of tilting) (see 3.9.1.1);
- special conditions if the instrument is designed to be used for weighing liquid products;
- description of special positions (e.g. weighing window) for the load receptor to ensure acceptable conditions during the weighing operation; and
- description of detectors or sensors that may be used to ensure that the weighing conditions are met (applicable e.g. for mobile instruments used outside in open locations).

4.18.1 Mobile instruments used outside in open locations (see also 3.9.1.1 d)

Note: This section also applies to special indoor applications with uneven grounds or floors (e.g. fork lift vehicles in halls with uneven floors).

The instrument shall have appropriate means to indicate that the limiting value of tilting has been exceeded (e.g. display switch-off, lamp, error signal), and to inhibit the printout and data transmission in that case.

After each moving of the vehicle a zero-setting or tare balancing operation shall occur automatically at least after switching-on of the weighing instrument.

On instruments with a weighing window (special positions or conditions of the load receptor) it shall be indicated, when the instrument is not within the weighing window (e.g. display switch-off, lamp, error signal) and the printout and data transmission shall be inhibited. Sensors, switches or other means may be used to recognize the weighing window.

If the load measuring device of the instrument is sensitive to influences depending on the moving or driving, it shall be equipped with an appropriate protection system.

5.3.5 applies during a warm-up time or procedure, e.g. if a hydraulic system is involved in the weighing process.

Where an automatic tilt sensor is also used to compensate the effect of tilting by adding a correction to the weighing result, this sensor is regarded as an essential part of the weighing instrument that shall be submitted to influence factors and disturbance tests during the type approval procedure.

Where a Cardanic (gimbal type) suspension is used, appropriate provisions shall be taken to prevent the indication, printing or data transmission of wrong weighing results if the suspended system or the load receptor comes into contact with the surrounding frame construction, especially when tilted to more than the limiting value.

The OIML Test Report shall include a description of the tilting tests to be performed at verification.

4.18.2 Other mobile instruments

Mobile instruments not intended to be used outside in open locations (e.g. wheel chair weighers, patient lifters) shall have a device to prevent the influence of tilting according to 3.9.1.1 a), b) or d). If they are equipped with a leveling device and a level indicator according to 3.9.1.1 a), the leveling device shall be operated easily without tools. They shall bear an appropriate inscription pointing the user to the necessity of leveling after each movement.

4.19 Portable instruments for weighing road vehicles

Portable weighbridges shall be identified as such in the application for type approval and in the issued corresponding OIML Certificate.

The applicant shall provide documentation describing the appropriate mounting surface.

Note 1: Groups of associated axle or wheel load weighers may be used for determining the total mass of the vehicle only if all wheels are supported simultaneously. Depending on national regulations, sequentially determining the axle or wheel loads using an axle/wheel weigher could be allowed to determine the total mass of a road vehicle, but this is not in the scope of this Recommendation. The total mass may be calculated from axle loads but this is not considered as being subject to legal control, for the reasons given in Note 2.

Note 2: When using single axle or wheel weighers the vehicle itself is the load and thus forms a link between the portable instrument and the fixed environment. This may lead to considerable errors if additional effects on the weighing result are not properly taken into account. These effects may be caused by:

- lateral forces due to interactions of the weighbridge with the vehicle;

- forces on part of the vehicle by different transient behavior and friction within the axle suspensions; or
- forces on part of the ramps if there are different levels between the weighbridge and ramp that could lead to varying distribution of the axle load.

4.20 Modes of operation

An instrument may have different modes of operation, which can be selected on manual command.

Examples of weighing modes are:

- weighing ranges;
- combinations of platforms;
- multi-interval or single interval instrument;
- operator or self-service mode;
- preset-tare setting; and
- display or instrument switching-off, etc.

Examples of non-weighing modes (modes in which weighing is inoperative) are:

- calculated values;
- sums;
- counting;
- percentage;
- statistics;
- calibration; and
- configuration; etc.

The mode which is actually in operation shall be clearly identified by a special sign, symbol or words in the language of the country, in which the instrument is used. In any case the requirements in 4.4.4 also apply.

In any mode and at any time it shall be possible to switch back to the weighing mode.

Automatic selection of the mode is only permitted within a weighing sequence (e.g. a fixed sequence of weighings to produce a mixture). At the end of the weighing sequence the instrument shall switch back to the weighing mode automatically.

When returning from a non-weighing mode to the weighing mode, the actual weight value may be displayed.

When returning from the switch-off condition (display or instrument switch-off) to the weighing mode, zero shall be displayed (automatic zero- or tare-setting). Alternatively the actual weight value may be displayed, but only if the correct zero position has been automatically checked before.

5 Technical requirements for electronic instruments

In addition to clauses 3 “Metrological requirements” and 4 “Technical requirements for a self- or semi-self-indicating instrument”, an electronic instrument shall comply with the following requirements.

5.1 General requirements

5.1.1 An electronic instrument shall be designed and manufactured such that, when it is exposed to disturbances, either:

- a) significant faults do not occur; or

- b) significant faults are detected and acted upon. The indication of significant faults in the display should not be confusing with other messages that appear in the display.

Note: A fault equal to or smaller than e is allowed irrespective of the value of the error of indication.

5.1.2 The requirements in 3.5, 3.6, 3.8, 3.9 and 5.1.1 shall be met durably, in accordance with the intended use of the instrument.

5.1.3 A type of an electronic instrument is presumed to comply with the requirements in 5.1.1, 5.1.2 and 5.3.2 if it passes the examinations and tests specified in 5.4.

5.1.4 The requirements in 5.1.1 may be applied separately to:

- a) each individual cause of significant fault; and/or
- b) each part of the electronic instrument.

The choice, whether 5.1.1 a) or 5.1.1 b) is applied, is left to the manufacturer.

5.2 Acting upon significant faults

When a significant fault has been detected, the instrument shall either be made inoperative automatically or a visual or audible indication shall be provided automatically and shall continue until such time as the user takes action or the fault disappears.

5.3 Functional requirements

5.3.1 Upon switch-on (of indication), a special procedure shall be performed that shows all relevant signs of the indicator in their active and non-active state sufficiently long to be checked by the operator. This is not applicable for displays on which failure becomes evident, e.g. non-segmented displays, screen-displays, matrix-displays, etc.

5.3.2 In addition to 3.9, an electronic instrument shall comply with the requirements at a relative humidity of 85 % whilst at the upper limit of the temperature range. This is not applicable to an electronic instrument of class I, nor of class II if e is less than 1 g.

5.3.3 Electronic instruments, class I instruments excepted, shall be subjected to the span stability test specified in 5.4.4. The error near maximum capacity shall not exceed the maximum permissible error and the absolute value of the difference between the errors obtained for any two measurements shall not exceed half the verification scale interval or half the absolute value of the maximum permissible error, whichever is greater.

5.3.4 When an electronic instrument is subjected to the disturbances specified in 5.4.3, the difference between the weight indication due to the disturbance and the indication without the disturbance (intrinsic error), shall not exceed e or the instrument shall detect and react to a significant fault.

5.3.5 During the warm-up time of an electronic instrument there shall be no indication or transmission of the weighing result.

5.3.6 An electronic instrument may be equipped with interfaces permitting the coupling of the instrument to any peripheral devices or other instruments.

An interface shall not allow the metrological functions of the instrument and its measurement data to be inadmissibly influenced by the peripheral devices (for example computers), by other interconnected instruments, or by disturbances acting on the interface.

Functions that are performed or initiated via an interface shall meet the relevant requirements and conditions of clause 4.

Note: An “interface” comprises all mechanical, electrical and logic properties at the data interchange point between an instrument and peripheral devices or other instruments.

5.3.6.1 It shall not be possible to introduce into an instrument, through an interface, instructions or data intended or suitable to:

- display data that are not clearly defined and which could be mistaken for a weighing result;
- falsify displayed, processed or stored weighing results;
- adjust the instrument or change any adjustment factor; however instructions may be given through the interface to carry out an adjustment procedure using a span adjustment device incorporated inside the instrument or, for instruments in class I, using an external standard weight or standard mass; or
- falsify primary indications displayed in case of direct sales to the public.

5.3.6.2 An interface through which the functions mentioned in 5.3.6.1 cannot be performed or initiated, need not be secured. Other interfaces shall be secured as per 4.1.2.4.

5.3.6.3 An interface intended to be connected to a peripheral device to which the requirements of this Recommendation apply, shall transmit data relating to primary indications in such a manner that the peripheral device can meet the requirements.

5.4 Performance and span stability tests

5.4.1 Test considerations

All electronic instruments of the same category, whether or not equipped with checking facilities, shall be subjected to the same performance test program.

5.4.2 State of instrument under test

Performance tests shall be carried out on fully operational equipment in its normal operational state or in a status as similar as possible thereto. When connected in other than a normal configuration, the procedure shall be mutually agreed by the approval authority and the applicant and shall be described in the test document.

If an electronic instrument is equipped with an interface permitting the coupling of the instrument to external equipment, the instrument shall, during the tests B.3.2, B.3.3 and B.3.4, be coupled to external equipment, as specified by the test procedure.

5.4.3 Performance tests

Performance tests shall be performed according to B.2 and B.3.

Table 10

Test	Characteristic under test
Static temperatures	Influence factor
Damp heat, steady state	Influence factor
Voltage variations	Influence factor
AC mains voltage dips and short interruptions	Disturbance
Bursts (transients)	Disturbance
Electrostatic discharge	Disturbance
Surge (if applicable)	Disturbance
Immunity to radiated electromagnetic fields	Disturbance
Immunity to conducted radio-frequency fields	Disturbance
Special EMC requirements for instruments powered from road vehicle power supply	Disturbance

5.4.4 Span stability test

Span stability test shall be performed according to B.4.

5.5 Additional requirements for software-controlled electronic devices

Note: More general requirements for, and advice on software-controlled devices and measuring instruments may exist in other OIML publications.

5.5.1 Devices with embedded software

For instruments and modules with embedded software, the manufacturer shall describe or declare that the software of the instrument or module is embedded, i.e. it is used in a fixed hardware and software environment and cannot be modified or uploaded via any interface or by other means after securing and/or verification. In addition to the documentation required in 8.2.1.2 the manufacturer shall submit the following documentation:

- Description of the legally relevant functions;
- Software identification that is clearly assigned to the legally relevant functions;
- Securing measures foreseen to provide for evidence of an intervention.

The software identification shall be provided by the instrument and listed in the OIML Certificate.

Acceptable solution:

The software identification is provided in the normal operation mode by either:

- a clearly identified operation of a physical or soft key, button, or switch; or
- a continuously displayed version number or checksum, etc.

accompanied in both cases by clear instructions on how to check the actual software identification against the reference number (as listed in the OIML Certificate) marked on or displayed by the instrument.

5.5.2 Personal computers, instruments with PC components, and other instruments, devices, modules, and elements with programmable or loadable legally relevant software

Personal computers and other instruments / devices with programmable or loadable software may be used as indicators, terminals, data storage devices, peripheral devices, etc. if the following additional requirements are met.

Note: Although these devices may be complete weighing instruments with loadable software or PC-based modules and components, etc., in the following they will simply be called “PC”. A “PC” is always assumed if the conditions for embedded software according to 5.5.1 are not fulfilled.

5.5.2.1 Hardware requirements

PCs as modules incorporating the metrologically relevant analog component(s) shall be treated according to Annex C (Indicator), see Table 11, categories 1 and 2.

PCs acting as a purely digital module without incorporating metrologically relevant analog components (e.g. used as terminals or price-computing point-of-sale devices) shall be treated according to Table 11, categories 3 and 4.

PCs used as purely digital peripheral devices shall be treated according to Table 11, category 5.

Table 11 also specifies how detailed the documentation to be submitted for both analog and digital components of the PC shall be depending on the respective category (description of power supply, type of interfaces, mother board, housing, etc.).

Table 11 – Tests and required documentation for PCs used as modules or peripheral devices

Category		Necessary tests	Documentation	Remarks
No.	Description		Hardware components	
1	PC as a module, primary indications on the monitor, PC incorporates the metrologically relevant analog components (ADC) on a slot mounted circuit print board that is not shielded (“open device”), power supply device for the ADC from the PC or PC-bus system	ADC and PC tested as unit: <ul style="list-style-type: none"> tests as for indicators according to Annex C; pattern shall be equipped with the maximum possible configuration (maximum power consumption) 	ADC: As in 8.2.1.2 (circuit diagrams, layouts, descriptions, etc.) PC: As in 8.2.1.2 (manufacturer, type of the PC, type of housing, types of all modules, electronic devices and components including power supply device, data sheets, manuals, etc.)	Influences on the ADC from the PC possible (temperature, electromagnetic interference (EMC))
2	PC as a module, primary indications on the monitor, PC incorporates the ADC, but the built-in ADC has a shielded housing (“closed device”), power supply device for the ADC from the PC, but not via the PC-bus system	ADC and PC tested as unit: <ul style="list-style-type: none"> tests as for indicators according to Annex C; pattern shall be equipped with the maximum possible configuration (maximum power consumption) 	ADC: As in 8.2.1.2 (circuit diagrams, layouts, descriptions, etc.) PC: <u>Power supply device</u> : As in 8.2.1.2 (manufacturer, type, data sheet) <u>Other parts</u> : Only general description or information necessary concerning the form of housing, motherboard, processor type, RAM, floppy and hard disk drives, controller boards, video controller, interfaces, monitor, keyboard, etc.	Influences on the ADC from the power supply device of the PC possible (temperature, EMC) Other influences from the PC not critical New EMC tests (PC) necessary if the power supply device is changed
3	PC as purely digital module, primary indications on the monitor, ADC outside the PC in a separate housing, power supply device for the ADC from the PC	ADC: tests as for indicators according to Annex C using the monitor of the PC for the primary indications PC: according to 3.10.2	ADC: As for category 2 PC: Power supply device as for category 2, other parts as for category 4	Influence (only EMC) on the ADC from the power supply device of the PC possible Other influences from the PC not possible or not critical New EMC tests (PC) necessary if the power supply device is changed
4	PC as purely digital module, primary indication on the monitor, ADC outside the PC in a separate housing having its own power supply device	ADC: as for category 3 PC: as for category 3	ADC: As for category 2 PC: Only general description or information necessary, e.g. concerning type of motherboard, processor type, RAM, floppy and hard disk drives, controller boards, video controller, interfaces, monitor, keyboard	Influences (temperature, EMC) on the ADC from the PC not possible
5	PC as purely digital peripheral device	PC: According to 3.10.3	PC: As for category 4	

Note: PC = Personal Computer
ADC = Relevant analog component(s), including Analog to Digital Converter (see Figure 1)
EMC = Electromagnetic Compatibility

5.5.2.2 Software requirements

The legally relevant software of a PC, i.e. the software that is critical for measurement characteristics, measurement data and metrologically important parameters stored or transmitted, is considered as an essential part of a weighing instrument and shall be examined according to Annex G.2. The legally relevant software shall meet the following requirements.

- a) The legally relevant software shall be adequately protected against accidental or intentional changes. Evidence of an intervention such as changing, uploading or circumventing the legally relevant software shall be available until the next verification or comparable official inspection.

This requirement implies that:

The protection against intentional changes with special software tools is not the object of these requirements, because this is considered as criminal action. It can normally be assumed that it is not possible to influence legally relevant parameters and data, especially processed variable values, as long as they are processed by a program which fulfils these requirements. However, if legally relevant parameters and data, especially final variable values, will be transmitted out of the protected part of the software for applications or functions subject to legal control, they shall be secured to meet the requirements of 5.3.6.3. The legally relevant software with all data, parameters, variable values, etc. will be regarded as sufficiently protected, if they cannot be changed with common software tools. At the moment, for example, all kinds of text editors are regarded as common software tools.

Acceptable solution:

After program start, automatic calculation of a checksum for the machine code of the complete legally relevant software (at least a CRC-16 checksum with hidden polynomial) and comparison of the result with a stored fixed value. No start if the machine code is falsified.

- b) When there is associated software which provides other functions besides the measuring function(s), the legally relevant software shall be identifiable and shall not be inadmissibly influenced by the associated software.

This requirement implies that:

Associated software is separated from the legally relevant software in the sense that they communicate via a software interface. A software interface is regarded as being protective if:

- only a defined and allowed set of parameters, functions and data can be exchanged via this interface, in accordance with 5.3.6.1; and
- neither part can exchange information via any other link.

Software interfaces are part of the legally relevant software. Circumventing the protective interface by the user is considered as a criminal action.

Acceptable solution:

Definition of all functions, commands, data, etc. which are exchanged via the protective interface from the legally relevant software to all other connected software or hardware parts. Checking whether all functions, commands and data are allowed.

- c) Legally relevant software shall be identified as such and shall be secured. Its identification shall be easily provided by the device for metrological controls or inspections.

This requirement implies that:

The operating system or similar auxiliary standard software, such as video drivers, printer drivers or hard disk drivers, need not be included in the software identification.

Acceptable solution:

Calculation of a checksum over the machine code of the legally relevant software at runtime and indication on manual command. This checksum represents the legally relevant software and can be compared to the checksum defined at type approval.

d) In addition to the documentation outlined in 8.2.1.2 the special software documentation shall include:

- a description of the system hardware, e.g. block diagram, type of computer(s), type of network, if not described in the operating manual (see also Table 11);
- a description of the software environment for the legally relevant software, e.g. the operating system, required drivers, etc.;
- a description of all legally relevant software functions, legally relevant parameters, switches and keys that determine the functionality of the instrument, including a declaration of the completeness of this description;
- a description of the relevant measuring algorithms (e.g. stable equilibrium, price calculation, rounding);
- a description of the relevant menus and dialogues;
- the security measures (e.g. checksum, signature, audit trail);
- the complete set of commands and parameters (including a short description of each command and parameter) that can be exchanged between the legally relevant software and the associated software via the protective software interface, including a declaration of the completeness of the list;
- the software identification for the legally relevant software;
- if the instrument permits the downloading of software via modem or internet: a detailed description of the loading procedure and the securing measures against accidental or intentional changes;
- if the instrument does not permit the downloading of software via modem or internet: a description of the measures taken to prevent inadmissible uploading of legally relevant software; and
- in the case of long-term storage or transmission of data via networks, a description of the data sets and protection measures (see 5.5.3).

5.5.3 Data storage devices (DSD)

If there is a device, whether incorporated in the instrument or being part of the instrument as software solution or connected to it externally, that is intended to be used for long-term storage of weighing data (in the sense of T.2.8.5), the following additional requirements apply.

5.5.3.1 The DSD must have a storage capacity which is sufficient for the intended purpose.

Note: Regulation of the minimum duration for keeping information is outside the scope of this Recommendation and is probably left to national trade regulations. It is the responsibility of the owner of the instrument to have an instrument that has sufficient storage capacity to fulfill the requirements of his activity. Type examination will only check that the data are stored and retrieved correctly, and that there are adequate means provided to prevent the loss of data if the storage capacity is exhausted before the foreseen duration.

5.5.3.2 The legally relevant data stored must include all relevant information necessary to recall an earlier weighing.

Note: Legally relevant data are (see also T.2.8.1):

- gross or net values and tare values (if applicable, together with a distinction of tare and preset tare);
- the decimal sign(s);
- measurement unit(s) (may be encoded);
- identification of the data stored;

- the identification number of the instrument or load receptor if several instruments or load receptors are connected to the data storage device; and
- a checksum or other signature of the data stored.

5.5.3.3 The legally relevant data stored shall be adequately protected against accidental or intentional changes.

Examples of acceptable solutions:

- a) A simple parity check is considered sufficient in order to protect the data against accidental changes during transmission.
- b) The data storage device may be realized as an external software-controlled device using, for instance, the hard disk of a PC as the storage medium. In this case the respective software shall meet the software requirements in 5.5.2.2. If the stored data are either encrypted or secured by a signature (at least 2 bytes, e.g. a CRC-16 checksum with hidden polynomial) this will be considered sufficient in order to protect the data against intentional changes.

5.5.3.4 The legally relevant data stored shall be capable of being identified and displayed, where the identification number(s) shall be stored for later use and recorded on the official transaction medium. In case of a printout the identification number(s) shall be printed.

Example of an acceptable solution:

The identification may be realized as consecutive numbers or as the respective date and time (mm:dd:hh:mm:ss) of the transaction.

5.5.3.5 The legally relevant data shall be stored automatically.

Note: This requirement means that the storing function must not depend on the decision of the operating person. It is accepted, however, if intermediate weighings that are not used for the transaction are not stored.

5.5.3.6 Stored legally relevant data sets which are to be verified by means of the identification must be displayed or printed on a device subject to legal control.

5.5.3.7 DSDs are identified as a feature, option, or parameter on OIML Certificates if they are incorporated in the instrument or form part of the instrument as software solution.

6 Technical requirements for non-self-indicating instruments

A non-self-indicating instrument shall comply with clauses 3 and 4, as far as applicable. This clause gives complementary provisions corresponding to some of the requirements of clause 4.

While the provisions of 6.1 are mandatory, those of 6.2 contain “acceptable solutions” as introduced in clause 4.

Provisions for certain simple instruments that may be submitted directly for initial verification are given in 6.3-6.9. These simple instruments are:

- simple equal arm and 1/10 ratio beams;
- simple steelyards with sliding poises;
- Roberval and Béranger instruments;
- instruments with ratio platforms; and
- instruments of the steelyard type with accessible sliding poises.

6.1 Minimum sensitivity

An extra load equivalent to the absolute value of the maximum permissible error for the applied load, but not less than 1 mg, shall be placed on the instrument at equilibrium and shall cause a permanent displacement of the indicating element of at least:

1 mm for an instrument of class I or II;

2 mm for an instrument of class III or IIII with $\text{Max} \leq 30$ kg;

5 mm for an instrument of class III or IIII with $\text{Max} > 30$ kg.

The sensitivity tests shall be carried out by placing extra loads with a slight impact, in order to eliminate the effects of discrimination threshold.

6.2 Acceptable solutions for indicating devices

6.2.1 General provisions

6.2.1.1 Equilibrium indicating components

For an instrument with an indicating component which moves in relation to another indicating component, the two indices are of the same thickness and the distance between them does not exceed this thickness.

However, this distance may be equal to 1 mm, if the thickness of the indices is less than this value.

6.2.1.2 Securing

It is possible to secure the sliding poises, the removable masses and the adjusting cavities or the housings of such devices.

6.2.1.3 Printing

If the device permits printing, this is possible only if sliding bars or poises or a weight switching mechanism are each in a position corresponding to a whole number of scale divisions. Except for accessible sliding poises or bars, printing is possible only if the equilibrium indicating component is in the reference position to within the nearest half scale interval.

6.2.2 Sliding poise devices

6.2.2.1 Form of scale marks

On bars on which the scale interval is the verification scale interval of the instrument, the scale marks consist of lines of constant thickness. On other major (or minor) bars the scale marks consist of notches.

6.2.2.2 Scale spacing

The distance between scale marks is not less than 2 mm and is of sufficient length so that the normal machining tolerances for notches or scale marks do not cause an error in the weighing result exceeding 0.2 times the verification scale interval.

6.2.2.3 Stops

The displacement of sliding poises and minor bars is limited to the graduated part of major and minor bars.

6.2.2.4 Displaying components

Each sliding poise is provided with a displaying component.

6.2.2.5 Accessible sliding poise devices

There are no moving parts in sliding poises, except sliding minor bars.

There is no cavity on sliding poises that could accidentally hold foreign bodies.

It is possible to secure parts that are detachable.

The displacement of sliding poises and minor bars requires a certain effort.

6.2.3 Indication by use of metrologically controlled weights

The reduction ratios is in the form 10^k , k being an integer or zero.

On an instrument intended for direct sales to the public, the height of the raised edge of the weight receptor platform does not exceed one tenth of the greatest dimension of the platform, without being greater than 25 mm.

6.3 Conditions of construction

6.3.1 Equilibrium indicating components

An instrument shall be provided with two moving indices or one moving indicating component and a fixed datum mark, the respective position of which indicates the reference position of equilibrium.

On an instrument of class III or IIII designed to be used for direct sales to the public, the indices and scale marks shall allow equilibrium to be seen from opposite sides of the instrument.

6.3.2 Knives, bearings and friction plates

6.3.2.1 Types of connection

Levers shall only be fitted with knives; these shall be pivoted on bearings.

The line of contact between knives and bearings shall be a straight line.

Counter-beams shall be pivoted on knife-edges.

6.3.2.2 Knives

The knives shall be fitted to the levers in such a way that the invariability of the ratios of the lever arms is assured. They shall not be welded or soldered.

The edges of the knives of one and the same lever shall be practically parallel and shall be situated in one plane.

6.3.2.3 Bearings

The bearings shall not be welded or soldered to their supports or in their mountings.

It shall be possible for bearings of an instrument with ratio platforms and steelyards to oscillate in all directions on their supports or in their mountings. On such instruments anti-disconnection devices shall prevent the disconnection of articulated parts.

6.3.2.4 Friction plates

The longitudinal play of the knives shall be limited by friction plates. There shall be point contact between knife and friction plates and it shall be situated on the extension of the line(s) of contact between knife and bearing(s).

The friction plate shall form a plane through the point of contact with the knife and its plane shall be perpendicular to the line of contact between knife and bearing. It shall not be welded or soldered to the bearings or their support.

6.3.3 Hardness

Contact parts of knives, bearings, friction plates, sliding poise devices interlevers, interlever supports and links shall have a hardness of at least 58 Rockwell C.

6.3.4 Protective coating

A protective coating may be applied to the parts in contact of jointed components, provided that this does not lead to changes of metrological properties.

6.3.5 Tare devices

No instrument shall be fitted with a tare device.

6.4 Simple equal arm beam

6.4.1 Symmetry of the beams

The beam shall have two planes of symmetry: longitudinal and transversal. It shall be in equilibrium with or without the pans. Detachable parts which may be used equally well on either end of the beam shall be interchangeable and of equal mass.

6.4.2 Zero setting

If an instrument of class III or IIII is provided with a zero-setting device, this shall be a cavity below one of the pans.

This cavity may be secured.

6.5 Simple 1/10 ratio beam

6.5.1 Indication of the ratio

The ratio shall be indicated legibly and permanently on the beam in the form 1:10 or 1/10.

6.5.2 Symmetry of the beam

The beam shall have a longitudinal plane of symmetry.

6.5.3 Zero setting

The provisions of 6.4.2 apply.

6.6 Simple sliding poise instruments (steelyards)

6.6.1 General

6.6.1.1 Scale marks

The scale marks shall be lines or notches, either on the edge, or on the flat of the graduated shank.

The minimum scale spacing is 2 mm between notches and 4 mm between lines.

6.6.1.2 Pivots

The load per unit length on the knives shall be not more than 10 kg/mm.

The bores of bearings in the form of an annulus shall have a diameter at least equal to 1.5 times the largest dimension of the cross section of the knife.

6.6.1.3 Equilibrium indicating component

The length of the equilibrium indicating component, taken from the edge of the fulcrum knife-edge of the instrument, shall be not less than 1/15 of the length of the graduated part of the major sliding poise bar.

6.6.1.4 Distinctive mark

The head and the sliding poise of an instrument with detachable sliding poises shall bear the same distinctive mark.

6.6.2 Instruments with single capacity

6.6.2.1 Minimum distance between knife-edges

The minimum distance between knife-edges is:

- 25 mm for maximum capacities ≤ 30 kg, and
- 20 mm for maximum capacities > 30 kg.

6.6.2.2 Graduation

The graduation shall extend from zero to the maximum capacity.

6.6.2.3 Zero-setting

If an instrument of class III or IIII is provided with a zero-setting device, this shall be a captive screw or nut arrangement with a maximum effect of 4 verification scale intervals per revolution.

6.6.3 Instruments with dual capacity

6.6.3.1 Minimum distance between knife-edges

The minimum distance between the knife-edges is:

- 45 mm for the lower capacity; and
- 20 mm for the higher capacity.

6.6.3.2 Differentiation of suspension mechanisms

The suspension mechanism of an instrument shall be differentiated from the load suspension mechanism.

6.6.3.3 Numbered scales

The scales corresponding to each of the capacities of the instrument shall permit weighing from zero to maximum capacity, without a break in continuity:

- either without the two scales having a common part; or
- with a common part of not more than 1/5 of the highest value of the lower scale.

6.6.3.4 Scale intervals

The scale intervals of each of the scales shall have a constant value.

6.6.3.5 Zero-setting devices

Zero-setting devices are not permitted.

6.7 Roberval and Béranger instruments

6.7.1 Symmetry

Detachable symmetrical parts occurring in pairs shall be interchangeable and of equal mass.

6.7.2 Zero-setting

If an instrument is provided with a zero-setting device, this shall be a cavity below the support of one of the pans. This cavity may be secured.

6.7.3 Length of the knife-edges

On an instrument having a simple beam:

- the distance between the outward ends of the load knife-edges shall be at least equal to the diameter of the bottom of the pan; and
- the distance between the outward ends of the centre knife-edge shall be at least equal to 0.7 times the length of the load knife-edges.

A double beam instrument shall have a stability of the mechanism equal to that obtained with a simple beam instrument.

Figure 7

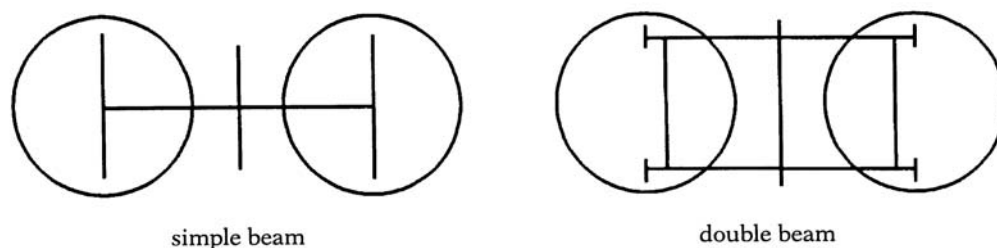

6.8 Instruments with ratio platforms

6.8.1 Maximum capacity

The maximum capacity of the instrument shall be greater than 30 kg.

6.8.2 Indication of the ratio

The ratio between the weighed load and the equilibrium load shall be indicated legibly and permanently on the beam in the form 1:10 or 1/10.

6.8.3 Zero-setting

An instrument shall have a zero-setting device consisting of either:

- a cup with a very convex cover; or
- a captive screw or nut arrangement, with a maximum effect of four verification scale intervals per revolution.

6.8.4 Complementary balancing devices

If an instrument is provided with a complementary device that avoids the use of weights which are of low value in relation to the maximum capacity, this device shall be a graduated steelyard with a sliding poise, the effect being additive and not more than 10 kg.

6.8.5 Locking of the beam

An instrument shall have a manual device for locking the beam, the action of which prevents the equilibrium indices coinciding when at rest.

6.8.6 Provisions relating to wooden parts

If certain parts of an instrument, such as the frame, the platform or the board are of wood, this shall be dry and free from defects. It shall be covered with a paint or an effective protective varnish.

No nails shall be used for the final assembly of wooden parts.

6.9 Instruments with a load-measuring device having accessible sliding poises (of the steelyard type)

6.9.1 General

The provisions of 6.2 relating to load measuring devices with accessible sliding poises shall be observed.

6.9.2 Range of numbered scale

The numbered scale of the instrument shall permit continuous weighing from zero to the maximum capacity.

6.9.3 Minimum scale spacing

The scale spacing i_x of the different bars ($x = 1, 2, 3...$) corresponding to the scale interval, d_x , of these bars, shall be:

$$i_x \geq (d_x/e) \times 0.05 \text{ mm, but } i_x \geq 2 \text{ mm}$$

6.9.4 Ratio platform

If an instrument is provided with a ratio platform for extending the indicating range of the numbered scale, the ratio between the value of the weights placed on the platform to balance a load and the load itself shall be 1/10 or 1/100.

This ratio shall be indicated legibly and permanently on the beam in a position close to the ratio platform, in the form: 1:10, 1:100, or 1/10, 1/100.

6.9.5 Zero-setting

The provisions of 6.8.3 apply.

6.9.6 Locking of the beam

The provisions of 6.8.5 apply.

6.9.7 Wooden parts

The provisions of 6.8.6 apply.





7 Marking of instruments and modules**7.1 Descriptive markings**

Note: The descriptive markings given here are by way of example, but variable according to national regulations.

An instrument shall carry the following markings.

7.1.1 Compulsory in all cases

- Manufacturer's mark, or name written in full (A);
- Metrological markings (B):
 - Indication of accuracy class in the form of a Roman number in an oval (see footnote to 3.1.1):

for special accuracy:	
for high accuracy:	
for medium accuracy:	
for ordinary accuracy:	
 - Maximum capacity in the form: Max ...
 - Minimum capacity in the form: Min ...
 - Verification scale interval in the form: $e = \dots$

7.1.2 Compulsory if applicable

- Name or mark of manufacturer's agent for an imported instrument (C);
- Serial number (D);
- Identification mark on each unit of an instrument consisting of separate but associated units (E);
- Type approval mark (F);

- Supplementary metrological characteristics (G):
 - software identification (compulsory for software-controlled instruments)
 - scale interval, if $d < e$, in the form: $d =$
 - maximum additive tare effect, in the form: $T = + \dots$
 - maximum subtractive tare effect if different from Max, in the form: $T = - \dots$
 - counting ratio on a counting instrument according to 4.17, in the form: $1: \dots$ or $1/ \dots$
 - range of plus/minus indication of a digital comparator instrument, in the form: $\pm \dots u_m$ or $- \dots u_m / + \dots u_m$
(u_m standing for the unit of mass as in 2.1)
 - ratio between weight platform and load platform as specified in 6.5.1, 6.8.2 and 6.9.4;
- Special limits (H):
 - maximum safe load, in the form: $Lim = \dots$
(if the manufacturer has provided for a maximum safe load of more than $Max + T$)
 - the special temperature limits according to 3.9.2.2 within which the instrument complies with the prescribed conditions of correct operation, in the form: $\dots \text{ }^\circ\text{C} / \dots \text{ }^\circ\text{C}$.

7.1.3 Additional markings (I)

Additional markings may, if necessary, be required on an instrument according to its particular use or to certain special characteristics, such as:

- not to be used for direct sales to the public/commercial transactions;
- to be used exclusively for:
- the stamp does not guarantee/guarantees only:
- to be used only as follows:

These additional markings may be either in the national language or in form of adequate, internationally agreed and published pictograms or signs.

7.1.4 Presentation of descriptive markings

The descriptive markings shall be indelible and of a size, shape and clarity allowing easy reading.

They shall be grouped in one or two clearly visible places either on a plate or sticker fixed permanently to the instrument, or on a non removable part of the instrument itself. In case of a plate or sticker which is not destroyed when removed, a means of securing shall be provided, e.g. a control mark that can be applied.

As an alternative all applicable markings in 7.1.1 (B) and 7.1.2 (G) above may be simultaneously displayed by a software solution either permanently or on manual command. In this case the markings are considered as device-specific parameters (see T.2.8.4, 4.1.2.4 and 5.5).

The markings: Max ...,
Min ...,
 $e = \dots$, and
 $d = \dots$ if $d \neq e$

shall be shown at least in one place and permanently either on the display or near to the display in a clearly visible position. All additional information as mentioned in 7.1.1 (B) and 7.1.2 (G) above may be shown alternatively on a plate or simultaneously displayed by a software solution either permanently or accessed by a simple manual command. In this case the markings are considered as device-specific parameters (see T.2.8.4, 4.1.2.4 and 5.5).

It shall be possible to seal the plate bearing the descriptive markings unless its removal will result in its destruction. If the data plate is sealed, it shall be possible to apply a control mark to it.

Acceptable solutions:a) Marking of Max, Min, e ... and d if $d \neq e$:

These values are permanently and simultaneously shown on the display of the weighing result as long as the instrument is switched on.

They may be automatically scrolled (displayed alternating one after each other) in one display. Automatically scrolling (but not on manual command) is considered as “permanently”.

b) Marking for multi-interval and multi range instruments:

In special cases, some of the markings should be in the form of a table. See examples in Figure 8.

Figure 8

For a multi-interval instrument	For an instrument with more than one weighing range (W_1 , W_2)			For an instrument with weighing ranges in different classes		
		W_1	W_2		W_1	W_2
Max 2/5/15 kg	Max	20 kg	100 kg	Max	1 000 g	5 000 g
Min 20 g	Min	200 g	1 kg	Min	1 g	40 g
$e = 1/2/5$ g	$e =$	10 g	50 g	$e =$	0.1 g	2 g
				$d =$	0.02 g	2 g

c) Fixing

If a plate is used it shall be secured e.g. by rivets or screws with one of the rivets of red copper or material having qualities recognized as similar or by using non removable control marks.

It should be possible to secure the head of one of the screws by appropriate means (e.g. by means of a cap of suitable material inserted in a device that cannot be dismantled or other appropriate technical solution).

The plate may be glued or consist of a transfer provided its removal results in its destruction.

d) Dimensions of the letters

The height of capital letters should be at least 2 mm.

7.1.5 Specific cases

7.1.1-7.1.4 apply in their entirety to a simple instrument made by one manufacturer.

When a manufacturer builds a complex instrument or when several manufacturers are involved in making a simple or complex instrument, the following additional provisions shall be applied.

7.1.5.1 Instruments having several load receptors and load measuring devices

Each load measuring device which is connected or can be connected to one or more load receptors, shall bear the descriptive markings relating to these, with:

- identification mark;
- maximum capacity;
- minimum capacity;
- verification scale interval; and
- maximum safe load and maximum additive tare effect (if appropriate).

7.1.5.2 Instruments consisting of separately-built main parts

If main parts cannot be exchanged without altering the metrological characteristics of the instrument, each unit shall have an identification mark which shall be repeated in the descriptive markings.

7.1.5.3 Separately tested modules

For load cells having an OIML R 60 Certificate, the markings according to OIML R 60 apply.

For other modules (indicators and weighing modules) the markings according to Annex C or D apply. Each module shall, however, bear at least the following descriptive markings for identification:

- type designation;
- serial number; and
- manufacturer (mark or name).

Other relevant information and characteristics shall be specified in the respective OIML Certificate (kind of module, fraction p_i of the maximum permissible error, OIML Certificate number, accuracy class, Max, e , etc.) and should be written in a document accompanying the respective module.

7.1.5.4 Peripheral devices

Peripheral devices that are mentioned in an OIML Certificate shall bear the following descriptive markings:

- type designation;
- serial number;
- manufacturer; and
- other information as far as applicable.

7.2 Verification marks

An instrument shall have a place for the application of verification marks.

This place shall:

- be such that the part on which it is located cannot be removed from the instrument without damaging the marks;
- allow easy application of the marks without changing the metrological qualities of the instrument; and
- normally be visible without the instrument having to be moved when it is in service.

Note: If technical reasons restrict or limit the verification mark(s) to be fixed only in a “hidden” place (e.g. when an instrument – in combination with another device – is integrated in other equipment) this can be accepted if these marks are easily accessible, and if there is a legible notice provided on the instrument in a clearly visible place that points to these marks or if its location is defined in the operation manual, the OIML Certificate and OIML Test Report.

Acceptable solution:

An instrument required to bear verification marks shall have a verification mark support, at the place provided for above, which ensures the conservation of the marks:

- a) when the mark is made with a stamp, this support may consist of a strip of suitable metal or any other material with qualities similar to lead (for example plastic, brass, etc. depending on national legislation), inserted into a plate fixed to the instrument, or a cavity bored in the instrument; or
- b) when the mark is of the self-adhesive type, a space should be provided on the instrument for the application of this mark.

For application of the verification marks a stamping area of at least 150 mm² is required.

If self-adhesive stickers are used as verification marks the space for these stickers should have a diameter of at least 15 mm. These marks should be adequately durable for the intended use of the instrument, e.g. by means of suitable protection.

8 Metrological controls

8.1 Liability to metrological controls

National legislation may impose controls to ensure that instruments used in specific applications comply with the requirements of this Recommendation.

If controls are imposed for conformity, they may consist of type approval and initial verification (or equivalent conformity assessment procedures) and subsequent – e.g. periodic verifications or service inspections or other equivalent metrological control procedures.

However, instruments according to 6.4-6.9 of this Recommendation shall not be subject to type approval, and national legislation may provide for initial verification without type approval for particular instrument applications.

8.2 Type approval

8.2.1 Application for type approval

The application for type approval shall include the submission to the approving authority of normally one instrument representative of the submitted type. The modular approach (3.10.2) and testing of a family of instruments or modules (3.10.4) may be more appropriate and efficient.

The applicant shall provide the following information, as far as applicable and in accordance with national legislation.

8.2.1.1 Metrological characteristics

- characteristics of the instrument, as in 7.1; and
- specifications of the modules or components of the measuring system as in 3.10.2.

8.2.1.2 Descriptive documents

Note: The numbers in parentheses in the table below refer to clauses in this Recommendation.

Item	Documentation required
1	General description of the instrument, description of the function, intended purpose of use, kind of instrument (e.g. platform, plus-minus scale, price labeler).
2	General characteristics (manufacturer; Class, Max, Min, e , n , single-/multi-interval, multiple range, temperature range, voltage, etc.).
3	List of descriptions and characteristic data of all devices and modules of the instrument.
4	Drawings of general arrangement and details of metrological interest including details of any interlocks, safeguards, restrictions, limits, etc.
4.1	Securing components, adjustment devices, controls, etc. (4.1.2), protected access to set-up and adjustment operations (4.1.2.4).
4.2	Place for application of control marks, securing elements, descriptive markings, identification, conformity and/or approval marks (7.1, 7.2).
5	Devices of the instrument.
5.1	Auxiliary, or extended indicating devices (3.4, 4.4.3, 4.13.7).

Item	Documentation required
5.2	Multiple use of indicating devices (4.4.4).
5.3	Printing devices (4.4.5, 4.6.11, 4.7.3, 4.14.4, 4.16).
5.4	Memory storage devices (4.4.6).
5.5	Zero-setting, zero-tracking devices (4.5, 4.6.9, 4.13.2).
5.6	Tare devices (4.6, 4.10, 4.13.3) and preset tare devices (4.7, 4.13.4).
5.7	Leveling device and level indicator, tilt sensor, upper limit of tilting (3.9.1).
5.8	Locking devices (4.8, 4.13.5) and auxiliary verification devices (4.9).
5.9	Selection of weighing ranges on multiple range instruments (4.10).
5.10	Connection of different load receptors (4.11).
5.11	Interfaces (types, intended use, immunity to external influences instructions (5.3.6)).
5.12	Peripheral devices, e.g. printers, secondary displays, for including in the type approval certificate and for connection for the disturbance tests (5.4.2).
5.13	Functions of price-computing instruments (e.g. for direct sales to the public) (4.14), self-service (4.13.11), price labeling (4.16).
5.14	Other devices or functions, e.g. for purposes other than determination of mass (not subject to conformity assessment).
5.15	Detailed description of the stable equilibrium function (4.4.2, A.4.12) of the instrument.
6	Information concerning special cases.
6.1	Subdivision of the instrument in modules - e.g. load cells, mechanical system, indicator, display - indicating the functions of each module and the fractions p_i . For modules that have already been approved, reference to test certificates or type approval certificates (3.10.2), reference to evaluation to R 60 for load cells (Annex F).
6.2	Special operating conditions (3.9.5).
6.3	Reaction of the instrument to significant faults (5.1.1, 5.2, 4.13.9).
6.4	Functioning of the display after switch-on (5.3.1).
7	Technical description, drawings and plans of devices, sub-assemblies, etc. particularly those in 7.1-7.4.
7.1	Load receptor, lever systems if not according to (6.3.2-6.3.4), force transmitting devices.
7.2	Load cells, if not presented as modules.
7.3	Electrical connection elements, e.g. for connecting load cells to the indicator, including length of signal lines (necessary for surge test, see B.3.3).
7.4	Indicator: block diagram, schematic diagrams, internal processing and data exchange via interface, keyboard with function assigned to any key.
7.5	Declarations of the manufacturer, e.g. for interfaces (5.3.6.1), for protected access to set-up and adjustment (4.1.2.4), for other software based operations.
7.6	Samples of all intended printouts.
8	Results of tests performed by the manufacturer or from other laboratories, on protocols from R 76-2, including proof of competence.
9	Certificates of other type approvals or separate tests, relating to modules or other parts mentioned in the documentation, together with test protocols.
10	For software controlled instruments or modules, additional documents according to 5.5.1 and 5.5.2.2 (Table 11).
11	Drawing or photo of the instrument showing the principle and the location of verification and securing marks are to be applied, which is necessary to be included in the OIML Certificate or Test Report.

All documents of the weighing instrument with the exception of the drawing or photograph (item 11) shall be kept confidential by the approving authority, except to the extent agreed with the manufacturer.

8.2.2 Type evaluation

The submitted documents shall be examined to verify compliance with the requirements of this Recommendation.

Suitable checks shall be performed to establish confidence that the functions are performed correctly in accordance with the submitted documents. Reactions to significant faults need not be triggered.

The instruments shall, on the basis of 3.10 and with test standards according to 3.7.1, be submitted to the testing procedures of Annex A, and of Annex B if applicable. For peripheral devices see 3.10.3.

It may be feasible to perform the tests on premises other than those of the authority.

The approving authority may, in special cases, require the applicant to supply test loads, equipment and personnel to perform the tests.

The approving authorities are advised to consider the possibility of accepting, with the consent of the applicant, test data obtained from other national authorities, without repeating these tests*.

They may, at their discretion and under their responsibility, accept test data provided by the applicant for the submitted type, and reduce their own tests accordingly*.

* Refer to OIML B 3 [3], B 10-1 and B 10-2 [23].

8.3 Initial verification

Initial verification may be performed by authorized personnel according to national regulations.

Initial verification shall not be performed unless conformity of the instrument to the approved type and/or the requirements of this Recommendation is established. The instrument shall be tested at the time of installation and ready for use, unless it can be readily shipped and installed after initial verification.

Initial verification may be carried out at the manufacturer's facility or at any other location:

- a) if transport to the location of use does not require dismantling of the instrument;
- b) if putting the instrument into service at its location of use does not require assembly of the instrument or other technical installation work likely to affect the instrument's performance; and
- c) if the gravity value at the location at which the instrument will be put into service is taken into consideration or if the instrument's performance is insensitive to gravity variations.

In all other cases, the tests shall be carried out at the location where the instrument will be used.

If the instrument's performance is sensitive to gravity variations the procedures of verification may be carried out in two stages, where the second stage shall comprise all examinations and tests of which the outcome is gravity-dependent, and the first stage all other examinations and tests. The second stage shall be carried out at the location where the instrument will be used.

Instead of a location of use, a gravity zone or a zone of use may be defined provided that the instrument meets the respective national or regional requirements as regards gravity.

8.3.1 Conformity

A declaration of conformity to the approved type and/or this Recommendation shall cover:

- correct operation of all devices, e.g. zero-setting, tare, and calculating devices;
- construction material and design, as far as they are of metrological relevance;

- proof of compatibility of the modules if the modular approach according to 3.10.2 has been chosen; and
- if appropriate, a list of the tests performed.

8.3.2 Visual inspection

Before testing, the instrument shall be visually inspected for:

- metrological characteristics, i.e. accuracy class, Min, Max, e , d ;
- identification of software if applicable;
- identification of modules if applicable; and
- prescribed inscriptions and positions for verification and control marks.

If the location and conditions of use of the instrument are known, it should be considered whether they are appropriate.

8.3.3 Tests

Tests shall be carried out to verify compliance with the following requirements:

- 3.5.1, 3.5.3.3 and 3.5.3.4: errors of indication (refer to A.4.4 to A.4.6, but five loading steps are normally sufficient, the test loads selected shall include Min only if $\text{Min} \geq 100 \text{ mg}$);
- 4.5.2 and 4.6.3: accuracy of zero-setting and tare devices (refer to A.4.2.3 and A.4.6.2);
- 3.6.1: repeatability (refer to A.4.10, 3rd paragraph);
- 3.6.2: eccentric loading (refer to A.4.7);
- 3.8: discrimination (refer to A.4.8); not applicable for instruments with digital indication;
- 4.18: tilt in case of mobile instruments (refer to A.5.1.3); and
- 6.1: sensitivity of non-self-indicating instruments (refer to A.4.9).

Other tests may be performed in special cases, e.g. in the case of unusual construction, doubtful results, or as indicated in the respective OIML Certificate.

The authority responsible may, in special cases, require the applicant to supply test loads, equipment and personnel to perform the tests (refer to 3.7).

For all tests, the error limits to be respected shall be the maximum permissible errors upon initial verification. If the instrument is to be shipped to another location after initial verification, the difference in local gravity acceleration between the locations of testing and use shall be considered appropriately, e.g. by a second stage of initial verification after adjustment or by taking into consideration the local gravity value of the location of use during initial verification.

8.3.4 Marking and securing

According to national legislation, initial verification may be testified by verification marks. These marks may indicate the month or year when initial verification took place, or when reverification is due. National legislation may also require securing of components whose dismantling or maladjustment might alter the metrological characteristics of the instrument without the alterations being clearly visible. The provisions of 4.1.2.4 and 7.2 shall be observed.

8.4 Subsequent metrological control

Subsequent metrological control may be performed by authorized personnel according to national regulations.

8.4.1 Subsequent verification

Upon subsequent verification, normally only inspection and tests according to 8.3.2 and 8.3.3 shall be performed, the error limits being those on initial verification. Stamping and securing may take place according to 8.3.4, the date being that of the subsequent verification.

8.4.2 Service inspection

Upon service inspection normally only inspection and tests according to 8.3.2 and 8.3.3 shall be performed, the error limits being twice those on initial verification. Stamping and securing may remain unchanged, or renewed according to 8.4.1.

**ANNEX A
(Mandatory)**

**Testing procedures for
non-automatic weighing instruments**

A.1 Administrative examination (8.2.1)

Review the documentation that is submitted, including necessary photographs, drawings, relevant technical specifications of main components, etc., to determine if it is adequate and correct. Consider the operating manual or equivalent user documentation.

Note: An “operating manual” may be a draft.

A.2 Compare construction with documentation (8.2.2)

Examine the various devices of the instrument to ensure compliance with the documentation. Consider also 3.10.

A.3 Initial examination

A.3.1 Metrological characteristics

Note the metrological characteristics according to the Test Report Format (R 76-2).

A.3.2 Descriptive markings (7.1)

Check the descriptive markings according to the checklist given in the Test Report Format.

A.3.3 Stamping and securing (4.1.2.4 and 7.2)

Check the arrangements for stamping and securing according to the checklist given in the Test Report Format.

A.4 Performance tests

A.4.1 General conditions

A.4.1.1 Normal test conditions (3.5.3.1)

Errors shall be determined under normal test conditions. When the effect of one factor is being evaluated, all other factors are to be held relatively constant, at a value close to normal.

For instruments of class I all necessary corrections in respect to influence factors due to the test load shall be applied, i.e. influence of air buoyancy.

A.4.1.2 Temperature

The tests shall be performed at a steady ambient temperature, usually normal room temperature unless otherwise specified.

The temperature is deemed to be steady when the difference between the extreme temperatures noted during the test does not exceed one-fifth of the temperature range of the given instrument without

being greater than 5 °C (2 °C in the case of a creep test), and the rate of change does not exceed 5 °C per hour.

A.4.1.3 Power supply

Instruments using electric power shall normally be connected to the mains power or power supply device and switched on throughout the tests.

A.4.1.4 Reference position before tests

For an instrument liable to be tilted, the instrument shall be leveled at its reference position.

A.4.1.5 Automatic zero-setting and zero-tracking

During the tests, the effect of the automatic zero-setting device or the zero-tracking device may be switched off or suppressed by starting the test with a load equal to say 10 e .

In certain tests where the automatic zero-setting or zero-tracking must be in operation (or not), specific mention of this is made in those test descriptions.

A.4.1.6 Indication with a scale interval smaller than e

If an instrument with digital indication has a device for displaying the indication with a smaller scale interval (not greater than 1/5 e), this device may be used to determine the error. If a device is used it should be noted in the Test Report.

A.4.1.7 Using a simulator to test modules (3.10.2 and 3.7.1)

If a simulator is used to test a module, the repeatability and stability of the simulator should make it possible to determine the performance of the module with at least the same accuracy as when a complete instrument is tested with weights, the mpe to be considered being those applicable to the module. If a simulator is used, this shall be noted in the Test Report Format and its traceability referenced.

A.4.1.8 Adjustment (4.1.2.5)

A semi-automatic span adjustment device shall be initiated only once before the first test.

An instrument of class I shall, if applicable, be adjusted prior to each test following the instructions in the operating manual.

Note: The temperature test A.5.3.1 is considered as one test.

A.4.1.9 Recovery

After each test the instrument should be allowed to recover sufficiently before the following test.

A.4.1.10 Preloading

Before each weighing test the instrument shall be pre-loaded once to Max or to Lim if this is defined, except for the tests in A.5.2 and A.5.3.2.

Where load cells are tested separately, the pre-loading shall follow OIML R 60.

A.4.1.11 Multiple range instruments

In principle, each range should be tested as a separate instrument. For instruments with automatic change over, however, combined tests can be possible.

A.4.2 Checking of zero

A.4.2.1 Range of zero-setting (4.5.1)

A.4.2.1.1 Initial zero-setting

With the load receptor empty, set the instrument to zero. Place a test load on the load receptor and switch the instrument off and then back on. Continue this process until, after placing a load on the load receptor and switching the instrument off and on, it does not re-zero. The maximum load that can be re-zeroed is the positive portion of the initial zero-setting range.

Remove any load from the load receptor and set the instrument to zero. Then remove the load receptor (platform) from the instrument. If, at this point, the instrument can be reset to zero by switching it off and back on, the mass of the load receptor is used as the negative portion of the initial zero-setting range.

If the instrument cannot be reset to zero with the load receptor removed, add weights to any live part of the scale (e.g. on the parts where the load receptor rests) until the instrument indicates zero again.

Then remove weights and, after each weight is removed, switch the instrument off and back on. The maximum load that can be removed while the instrument can still be reset to zero by switching it off and on is the negative portion of the initial zero-setting range.

The initial zero-setting range is the sum of the positive and negative portions. If the load receptor cannot readily be removed, only the positive part of the initial zero-setting range need be considered.

A.4.2.1.2 Non-automatic and semi-automatic zero-setting

This test is performed in the same manner as described in A.4.2.1.1, except that the zero-setting means is used rather than switching the instrument off and on.

A.4.2.1.3 Automatic zero-setting

Remove the load receptor as described in A.4.2.1.1 and place weights on the instrument until it indicates zero.

Remove weights in small amounts and after each weight is removed allow time for the automatic zero-setting device to function so as to see if the instrument is reset to zero automatically. Repeat this procedure until the instrument will not reset to zero automatically.

The maximum load that can be removed so that the instrument can still be reset to zero is the zero-setting range.

If the load receptor cannot readily be removed, a practical approach can be to add weights to the instrument and use another zero-setting device, if provided, to set the instrument to zero. Then remove weights and check whether the automatic zero-setting still sets the instrument to zero. The maximum load that can be removed so that the instrument can still be reset to zero is the zero-setting range.

A.4.2.2 Zero indicating device (4.5.5)

For instruments fitted with a zero indicating device and digital indication, adjust the instrument to about one scale interval below zero; then by adding weights equivalent, for example, to 1/10 of the scale interval, determine the range over which the zero indicating device indicates the deviation from zero.

A.4.2.3 Accuracy of zero-setting (4.5.2)

The test may be combined with A.4.4.1.

A.4.2.3.1 Non-automatic and semi-automatic zero-setting

The accuracy of the zero-setting device is tested by first loading the instrument to an indication as close as possible to a changeover point, and then by initiating the zero-setting device and determining the additional load at which the indication changes from zero to one scale interval above zero. The error at zero is calculated according to the description in A.4.4.3.

A.4.2.3.2 Automatic zero-setting or zero-tracking

The indication is brought out of the automatic range (e.g. by loading with $10 e$). Then the additional load at which the indication changes from one scale interval to the next above is determined and the error is calculated according to the description in A.4.4.3. It is assumed that the error at zero load would be equal to the error at the load in question.

A.4.3 Setting to zero before loading

For instruments with digital indication, the adjustment to zero, or the determination of the zero point is carried out as follows:

- a) For instruments with non-automatic zero-setting, weights equivalent to half a scale interval are placed on the load receptor, and the instrument is adjusted until the indication alternates between zero and one scale interval. Then weights equivalent to half a scale interval are removed from the load receptor to attain a centre of zero reference position.
- b) For instruments with semi-automatic or automatic zero-setting or zero-tracking, the deviation from zero is determined as described in A.4.2.3.

A.4.4 Determination of weighing performance

A.4.4.1 Weighing test

Apply test loads from zero up to and including Max, and similarly remove the test loads back to zero. When determining the initial intrinsic error, at least 10 different test loads shall be selected, and for other weighing tests at least 5 shall be selected. The test loads selected shall include Max and Min (Min only if $\text{Min} \geq 100 \text{ mg}$) and values at or near those at which the maximum permissible error (mpe) changes.

During type examination it should be noted that when loading or unloading weights the load shall be progressively increased or progressively decreased. It is recommended to apply the same procedure as far as possible during initial verification (8.3) and subsequent metrological control (8.4).

If the instrument is provided with an automatic zero-setting or zero-tracking device, it may be in operation during the tests, except for the temperature test. The error at zero point is then determined according to A.4.2.3.2.

A.4.4.2 Supplementary weighing test (4.5.1)

For instruments with an initial zero-setting device with a range greater than 20 % of Max, a supplementary weighing test shall be performed using the upper limit of the range as zero point.

A.4.4.3 Evaluation of error (A.4.1.6)

For instruments with digital indication and without a device for displaying the indication with a smaller scale interval (not greater than $1/5 e$), the changeover points are to be used to determine the indication of the instrument, prior to rounding, as follows.

At a certain load, L , the indicated value, I , is noted. Additional weights of say $1/10 e$ are successively added until the indication of the instrument is increased unambiguously by one scale interval ($I + e$).

The additional load ΔL added to the load receptor gives the indication P , prior to rounding by using the following formula:

$$P = I + \frac{1}{2} e - \Delta L$$

The error prior to rounding is:

$$E = P - L = I + \frac{1}{2} e - \Delta L - L$$

The corrected error prior to rounding is:

$$E_c = E - E_0 \leq mpe$$

where E_0 is the error calculated at zero or at a load close to zero (e.g. $10 e$).

Example: An instrument with a verification scale interval, e , of 5 g is loaded with 1 kg and thereby indicates 1 000 g. After adding successive weights of 0.5 g, the indication changes from 1 000 g to 1 005 g at an additional load of 1.5 g. Inserted in the above formula these observations give:

$$P = (1\ 000 + 2.5 - 1.5) \text{ g} = 1\ 001 \text{ g}$$

Thus the true indication prior to rounding is 1 001 g, and the error is:

$$E = (1\ 001 - 1\ 000) \text{ g} = + 1 \text{ g}$$

If the changeover point at zero as calculated above was $E_0 = + 0.5 \text{ g}$, the corrected error is:

$$E_c = + 1 - (+ 0.5) = + 0.5 \text{ g}$$

In the tests A.4.2.3 and A.4.11.1, the error shall be determined with a sufficient accuracy in view of the tolerance in question.

Note: The above description and formulae are also valid for multi-interval instruments. Where the load, L , and the indication, I , are in different partial weighing ranges:

- the additional weights ΔL are to be in steps of $1/10 e_i$,
- in the equation “ $E = P - L = \dots$ ” above, the term “ $\frac{1}{2} e$ ” is to be $\frac{1}{2} e_i$ or $\frac{1}{2} e_i + 1$ according to the partial weighing range in which the indication ($I + e$) appears.

A.4.4.4 Testing of modules

When testing modules separately, it shall be possible to determine the errors with a sufficiently small uncertainty considering the chosen fractions of the mpe either by using a device for displaying the indication with a scale interval smaller than $(1/5) p_i \times e$ or by evaluating the changeover point of the indication with an uncertainty better than $(1/5) p_i \times e$.

A.4.4.5 Weighing test using substitution material (3.7.3)

The test shall be carried out only during verification and at the place of use taking A.4.4.1 into account.

Determine the allowed number of substitutions according to 3.7.3.

Check the repeatability error at a load of about the value where the substitution is made, by placing it three times on the load receptor. The results of the repeatability test (A.4.10) may be used if the test loads have a comparable mass.

Apply test loads from zero up to and including the maximum quantity of standard weights.

Determine the error (A.4.4.3) and then remove the weights so that the no-load indication, or, in the case of an instrument with a zero-tracking device, the indication of say $10 e$, is reached.

Substitute the previous weights with substitution material until the same changeover point, as used for the determination of the error, is reached. Repeat the above procedure until Max of the instrument is reached.

Unload in reverse order to zero, i.e. unload the weights and determine the changeover point. Place the weights back and remove the substitution material until the same changeover point is reached. Repeat this procedure until no-load indication.

Similar equivalent procedures may be applied.

A.4.5 Instruments with more than one indicating device (3.6.3)

If the instrument has more than one indicating device, the indications of the various devices shall be compared during the tests described in A.4.4.

A.4.6 Tare

A.4.6.1 Weighing test (3.5.3.3)

Weighing tests (loading and unloading according to A.4.4.1) shall be performed with different tare values. At least 5 load steps shall be selected. The steps shall include values close to Min (Min only if $\text{Min} \geq 100 \text{ mg}$), values at or near those at which the maximum permissible error (mpe) changes and the value close to the maximum possible net load.

The weighing tests should be performed on instruments with:

- subtractive tare: with one tare value between 1/3 and 2/3 of maximum tare;
- additive tare: with two tare values of about 1/3 and 3/3 of maximum tare effect.

For 8.3 and 8.4, the practical test may be replaced by other appropriate procedures, e.g. by numerical or graphical considerations; simulation of a tare-balancing operation by displacement (shifting) of the error limits (mpe) to any points of the error curve (curve of weighing test results); or checking if the error curve and hysteresis are inside the mpe at every point.

If the instrument is provided with automatic zero-setting or zero-tracking device it may be in operation during the test, in which case the error at zero point shall be determined according to A.4.2.3.2.

A.4.6.2 Accuracy of tare setting (4.6.3)

The test may be combined with A.4.6.1.

The accuracy of the tare device shall be established in a manner similar to the test described in A.4.2.3 with the indication set to zero using the tare device.

A.4.6.3 Tare weighing device (3.5.3.4 and 3.6.3)

If the instrument has a tare weighing device, the results obtained for the same load (tare), by the tare weighing device and the indicating device, shall be compared.

A.4.7 Eccentricity tests (3.6.2)

Large weights should be used in preference to several small weights. Smaller weights shall be placed on top of larger weights, but unnecessary stacking should be avoided within the segment to be tested. The load shall be applied centrally in the segment if a single weight is used, but applied uniformly over the segment, if several small weights are used. It is sufficient to apply the load only to the eccentric segments, not to the centre of the load receptor.

Note: If an instrument is designed in such a way that loads may be applied in different manners, it may be appropriate to apply more than one of the tests described in A.4.7.1-A.4.7.5.

The location of the load shall be marked on a sketch in the Test Report.

The error at each measurement is determined according to A.4.4.3. The zero error E_0 used for the correction is the value determined prior to each measurement. Normally it is sufficient to determine the zero error only at the beginning of the measurement, but on special instruments (accuracy class I, high capacity, etc.) it is recommended that the zero error be determined prior to each eccentricity loading. However, if the mpe is exceeded, the test with zero error prior to each loading is necessary.

If the instrument is provided with automatic zero-setting or zero-tracking, it shall not be in operation during the following tests.

Note: If operating conditions are such that no eccentricity can occur, eccentricity tests need not be performed.

A.4.7.1 Instruments with a load receptor having not more than four points of support

The four quarter segments roughly equal to $\frac{1}{4}$ of the surface of the load receptor (as shown in the sketches in Figure 9 or similar sketches) shall be loaded in turn.

Figure 9

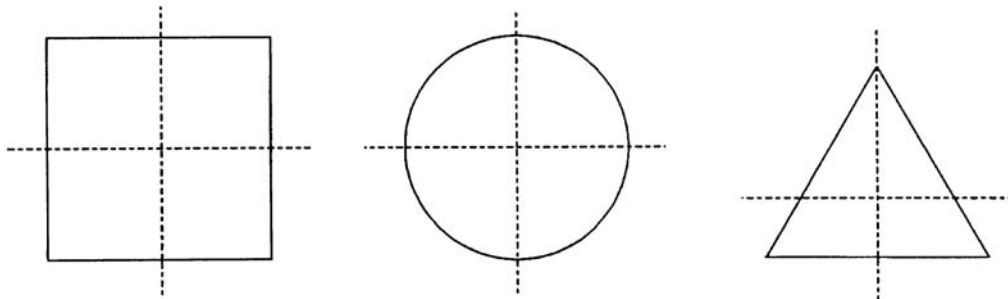

Examples: A load receptor which transmits the force from the load:

- directly into 1 single point load cell has 1 point of support;
- directly into 3 load cells has 3 points of support; and
- with 4 mechanical connection elements into a lever works has 4 points of support.

A.4.7.2 Instruments with a load receptor having more than four points of support

The load shall be applied over each support on an area of the same order of magnitude as the fraction $1/n$ of the surface area of the load receptor, where n is the number of points of support.

Where two points of support are too close together for the above-mentioned test load to be distributed as indicated above, the load shall be doubled and distributed over twice the area on both sides of the axis connecting the two points of support.

A.4.7.3 Instruments with special load receptors (tank, hopper, etc.)

The load shall be applied to each point of support.

A.4.7.4 Instruments used for weighing rolling loads (3.6.2.4)

A load shall be applied at different positions on the load receptor. These positions shall be at the beginning, the middle and at the end of the load receptor in the normal driving direction. The positions shall then be repeated in the reverse direction, if the application in both directions is possible. Before changing direction zero has to be determined again. If the load receptor consists of several sections, the test shall be applied to each section.

A.4.7.5 Eccentricity tests for mobile instruments

A.4.7 and A.4.7.1 to A.4.7.4 should be applied as far as these points are applicable. If not, the positions of the test loads during this test have to be defined according to the operational conditions of use.

A.4.8 Discrimination test (3.8)

The following tests shall be performed with three different loads, e.g. Min, $\frac{1}{2}$ Max and Max.

A.4.8.1 Non-self-indication and analog indication

An extra load, but not less than 1 mg, shall be placed gently on or removed from the load receptor while the instrument is at equilibrium. For certain extra load the equilibrium mechanism shall assume a different position of equilibrium, as specified.

A.4.8.2 Digital indication

This test applies only to type examination and to instruments with $d \geq 5$ mg.

A load plus sufficient additional weights (say 10 times $1/10 d$) shall be placed on the load receptor. The additional weights shall then be removed successively until the indication, I , is decreased unambiguously by one actual scale interval, $I - d$. One of the additional weights shall be placed back on the load receptor and a load equal to $1.4 d$ shall then be gently placed on the load receptor and give a result increased by one actual scale interval above the initial indication, $I + d$. See example in Figure 10.

Figure 10 – Instrument with $d = 10$ g

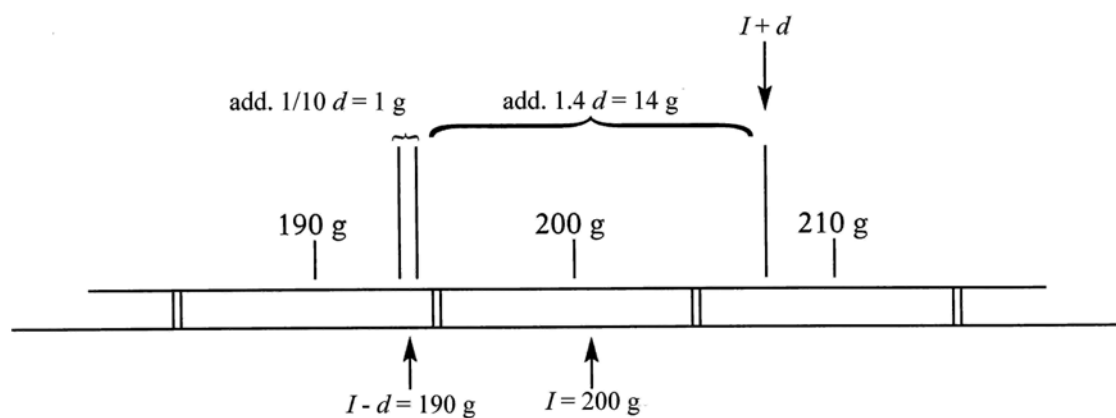

The indication at the start is $I = 200$ g.

Remove additional weights until the indication changes to $I - d = 190$ g.

Add $1/10 d = 1$ g and thereafter $1.4 d = 14$ g.

The indication shall then be $I + d = 210$ g.

A.4.9 Sensitivity of a non-self-indicating instrument (6.1)

During this test the instrument shall oscillate normally, and an extra load equal to the value of the mpe for the applied load, but not less than 1 mg, shall be placed on the instrument while the load receptor is still oscillating. For damped instruments the extra load shall be applied with a slight impact. The linear distance between the middle points of this reading and the reading without the extra load shall be taken as the permanent displacement of the indication. The test shall be performed with a minimum of two different loads (e.g. zero and Max).

A.4.10 Repeatability test (3.6.1)

For type approval two series of weighings shall be performed, one with a load of about 50 % and one with a load close to 100 % of Max. For instruments with Max less than 1 000 kg each series shall consist of 10 weighings. In other cases each series shall consist of at least 3 weighings. Readings shall be taken when the instrument is loaded, and when the unloaded instrument has come to rest between weighings. In the case of a zero deviation between the weighings, the instrument shall be reset to zero, without determining the error at zero. The true zero position need not be determined between the weighings.

If the instrument is provided with automatic zero-setting or zero-tracking, it shall be in operation during the test.

For verification one series of weighings with about 0.8 Max is sufficient. Three weighings on classes III and IIII or six weighings on classes I and II are necessary.

A.4.11 Variation of indication with time (for instruments of classes II, III or IIII only)**A.4.11.1 Creep test (3.9.4.1)**

Load the instrument close to Max. Take one reading as soon as the indication has stabilized and then note the indication while the load remains on the instrument for a period of four hours. During this test the temperature should not vary more than 2 °C.

The test may be terminated after 30 minutes if the indication differs less than 0.5 *e* during the first 30 minutes and the difference between 15 and 30 minutes is less than 0.2 *e*.

A.4.11.2 Zero return test (3.9.4.2)

The deviation in the zero indication before and after a period of loading with a load close to Max for half an hour, shall be determined. The reading shall be taken as soon as the indication has stabilized.

For multiple range instruments, continue to read the zero indication during the following 5 minutes after the indication has stabilized.

If the instrument is provided with automatic zero-setting or zero-tracking, it shall not be in operation.

A.4.12 Test for the stability of equilibrium (4.4.2)

Check the documentation of the manufacturer, whether the following stable equilibrium functions are described in detail and sufficiently:

- the basic principle, the function and the criteria for stable equilibrium;
- all adjustable and not adjustable parameters of the stable equilibrium function (time interval, number of measuring cycles, etc.);
- securing of these parameters; and
- definition of the most critical adjustment of the stable equilibrium (worst case). This shall cover all variants of a type.

Test the stable equilibrium with the most critical adjustment (worst case) and check that printing (or storing) is not possible when stable equilibrium is not yet reached.

Check that, under continuous disturbance of the equilibrium, no functions can be performed which require stable equilibrium, e.g. printing, storing, zero or tare operations.

Load the instrument up to 50 % of Max or up to a load included in the range of operation of the relevant function. Manually disturb the equilibrium by one single action and initiate the command for printing, data storage, or other function, as soon as possible. In the case of printing or data storage, read the indicated value over a period of 5 seconds following print-out. Stable equilibrium is considered to be achieved when no more than two adjacent values are indicated, one of which being

the printed value. For instruments with differentiated scale divisions, this paragraph applies to e rather than to d .

In the case of zero-setting or tare balancing, check the accuracy according to A.4.2.3/A.4.6.2. Perform the test 5 times.

In case of vehicle-mounted, vehicle-incorporated or mobile instruments, tests have to be performed with a known operational test load, the instrument being in motion to ensure either that the stability criteria inhibit any weighing operation or that the stable equilibrium criteria of 4.4.2 are met. In case the instrument can be used to weigh liquid products in a vehicle, tests should be performed in conditions where the vehicle is stopped just before testing so that either the stability criteria inhibit any weighing operation or that the stable equilibrium criteria of 4.4.2 are met.

A.4.13 Additional tests for portable weighbridges (4.19)

Note: Portable instruments have very different constructions for a large number of very different applications so that it is principally not possible to define uniform test procedures. Different requirements, conditions and specifications could be necessary depending on the construction and application and, of course, on the metrological demands (e.g. accuracy class). These should be mentioned and described in the respective Test Report. A.4.13 therefore only provides some general means for properly testing a portable instrument.

To be performed during type approval:

- At a site agreed with the manufacturer:
 - examine the evenness of the reference area (all points of support of the bridge being at the same level) and then perform an accuracy test and an eccentricity test; and
 - realize several reference areas with some different faults in the evenness (the values of these faults are to be equal to the limits given by the manufacturer) and then perform an eccentricity test for each configuration.
- At a site where the instrument is used:
 - examine the conformity to the requirements for the mounting surface; and
 - examine the installation and perform tests to establish conformity with the metrological requirements.

A.5 Influence factors

A.5.1 Tilting (only class II, III and IIII instruments) (3.9.1.1)

The instrument shall be tilted both forwards and backwards longitudinally, and from side to side, transversely.

In practice the tests (no-load and loaded) described in A.5.1.1.1 and A.5.1.1.2 can be combined as follows.

After zero-setting in the reference position, the indication (prior to rounding) is determined at no-load and at the two test loads. The instrument is then unloaded and tilted (without a new zero-setting), after which the indications at no load and at the two test loads are determined. This procedure is repeated for each of the tilting directions.

In order to determine the influence of tilting on the loaded instrument, the indication obtained at each tilt shall be corrected for the deviation from zero which the instrument had prior to loading.

If the instrument is provided with automatic zero-setting or zero-tracking, it shall not be in operation.

A.5.1.1 Tilting of instruments with a level indicator or automatic tilt sensor (3.9.1.1a and b)

A.5.1.1.1 Tilting at no-load

The instrument shall be set to zero in its reference position (not tilted). The instrument shall then be tilted longitudinally up to the limiting value of tilting. The zero indication is noted. The test shall be repeated with transverse tilting.

A.5.1.1.2 Tilting when loaded

The instrument shall be set to zero in its reference position and two weighings shall be carried out at a load close to the lowest load where the maximum permissible error changes, and at a load close to Max. The instrument is then unloaded and tilted longitudinally and set to zero. The tilting shall be equal to the limiting value of tilting. Weighing tests as described above shall be performed. The test shall be repeated with transverse tilting.

A.5.1.2 Other instruments (3.9.1.1 c)

For instruments liable to be tilted and neither fitted with a level indicator nor with an automatic tilt sensor the tests in A.5.1.1 shall be performed with a tilting of 50/1000 or, in case of an instrument with automatic tilt sensor, with a tilting equal to the limiting value of tilting as defined by the manufacturer.

A.5.1.3 Tilt test for mobile instruments used outside in open locations (3.9.1.1d and 4.18.1)

Appropriate load receptors for applying the test loads are to be provided by the applicant.

The tilt test shall be performed with the limiting value of tilting.

The instrument shall be tilted both forwards and backwards longitudinally, and from side to side, transversely.

Functional tests shall be performed to ensure that, if applicable, tilt sensors or inclination switches function properly especially when generating the signal that the maximum permissible tilt is reached or exceeded (e.g. display switch-off, error signal, lamp), and inhibiting transmission and printing of weighing results.

The test shall be performed near the switching-off point (in the case of an automatic tilt sensor) or near the tilt where the load receptor comes into contact with the surrounding frame construction (in the case of a cardanic suspension). This is the limiting value of tilting.

If the instrument is provided with automatic zero-setting or zero-tracking, it shall not be in operation.

The instrument shall be tested according to A.5.1 and A.5.1.1 or A.5.1.2.

A.5.2 Warm-up time test (5.3.5)

An instrument using electric power shall be disconnected from the supply for a period of at least 8 hours prior to the test. The instrument shall then be connected and switched on and as soon as the indication has stabilized, the instrument shall be set to zero and the error at zero shall be determined. Calculation of the error shall be made according to A.4.4.3. The instrument shall be loaded with a load close to Max. These observations shall be repeated after 5, 15 and 30 minutes. Every individual measurement performed after 5, 15, and 30 minutes, shall be corrected for the zero error at that time.

For instruments of class I, the provisions of the operating manual for the time following connection to the mains shall be observed.

A.5.3 Temperature tests

Note: See Figure 11 for a practical approach to performing the temperature tests.

A.5.3.1 Static temperatures (3.9.2.1 and 3.9.2.2)

The test consists of exposure of the equipment under test (EUT) to constant (see A.4.1.2) temperatures within the range stated in 3.9.2, under free air conditions, for a 2 hour period after the EUT has reached temperature stability.

The weighing tests (loading and unloading) shall be carried out according to A.4.4.1:

- at a reference temperature (normally 20 °C but for class I instruments the mean value of the specified temperature limits);
- at the specified high temperature;
- at the specified low temperature;
- at a temperature of 5 °C, if the specified low temperature is ≤ 0 °C; and
- at the reference temperature.

The change of temperature shall not exceed 1 °C/min during heating and cooling down.

For class I instruments, changes in barometric pressure shall be taken into account.

For weighing tests at the specified high temperature the relative humidity shall not exceed 20 g/m³.

Note: An absolute humidity of 20 g/m³ corresponds to a relative humidity of 39 % at 40 °C, of 50 % at 35 °C and of 66 % at 30 °C. These values are valid for an air pressure of 1 013.25 hPa [4].

A.5.3.2 Temperature effect on the no-load indication (3.9.2.3)

The instrument shall be set to zero and then changed to the prescribed highest and lowest temperatures as well as at 5 °C if applicable. After stabilization the error of the zero indication shall be determined. The change in zero indication per 1 °C (class I instruments) or per 5 °C (other instruments) shall be calculated. The changes of these errors per 1 °C (class I instruments) or per 5 °C (other instruments) shall be calculated for any two consecutive temperatures of this test.

This test may be performed together with the temperature test (A 5.3.1). The errors at zero shall then be additionally determined immediately before changing to the next temperature and after the 2 hour period after the instrument has reached stability at this temperature.

Note: Preloading is not allowed before these measurements.

If the instrument is provided with automatic zero-setting or zero-tracking, it shall not be in operation.

A.5.4 Voltage variations (3.9.3)

Stabilize the EUT under constant environmental conditions.

The test consists of subjecting the EUT to voltage variations according to A.5.4.1, A.5.4.2, A.5.4.3 or A.5.4.4.

The test shall be performed with test loads of 10 e and a load between ½ Max and Max.

If the instrument is provided with an automatic zero-setting device or a zero-tracking device, it may be in operation during the test, in which case the error at zero point shall be determined according to A.4.2.3.2.

In the following U_{nom} designates the nominal value marked on the instrument. In case a range is specified U_{min} relates to the lowest value and U_{max} to the highest value of the range.

Reference: [4], [17]

A.5.4.1 Variations of AC mains voltage

Test severity: Voltage variations: lower limit $0.85 U_{\text{nom}}$ or $0.85 U_{\text{min}}$
upper limit $1.10 U_{\text{nom}}$ or $1.10 U_{\text{max}}$

Maximum allowable variations: All functions shall operate as designed.
All indications shall be within the maximum permissible errors.

Note: Where an instrument is powered by a three phase supply, the voltage variations shall apply for each phase successively.

A.5.4.2 Variations of external or plug-in power supply device (AC or DC), including rechargeable battery power supply if (re)charge of batteries during the operation of the instrument is possible

Test severity: Voltage variations: lower limit minimum operating voltage (see 3.9.3)
upper limit: $1.20 U_{\text{nom}}$ or $1.20 U_{\text{max}}$

Maximum allowable variations: All functions shall operate as designed or the indication shall switch off.
All indications shall be within the maximum permissible errors.

A.5.4.3 Variations of non-rechargeable battery power supply, including rechargeable battery power supply if (re)charge of batteries during the operation of the instrument is not possible

Test severity: Voltage variations: lower limit: minimum operating voltage (see 3.9.3)
upper limit: U_{nom} or U_{max}

Maximum allowable variations: All functions shall operate as designed or the indication shall switch off.
All indications shall be within the maximum permissible errors.

A.5.4.4 Voltage variations of a 12 V or 24 V road vehicle battery

For specifications of the power supply used during the test to simulate the battery, refer to [21].

Test severity: Voltage variations: lower limit: minimum operating voltage (see 3.9.3)
upper limit 12 V battery: 16 V
upper limit 24 V battery: 32 V

Maximum allowable variations: All functions shall operate as designed or the indication shall switch off.
All indications shall be within the maximum permissible errors.

A.6 Endurance test (3.9.4.3)

Note: Applicable only to instruments of classes II, III and IIII with $\text{Max} \leq 100 \text{ kg}$.

The endurance test shall be performed after all other tests.

Under normal conditions of use, the instrument shall be subjected to the repetitive loading and unloading of a load approximately equal to 50 % of Max. The load shall be applied 100 000 times. The frequency and speed of application shall be such that the instrument attains an equilibrium when

loaded and when unloaded. The force of the load applied shall not exceed the force attained in a normal loading operation.

A weighing test in accordance with the procedure in A.4.4.1 shall be performed before the endurance test is started to obtain the intrinsic error. A weighing test shall be performed after the completion of the loadings to determine the durability error due to wear and tear.

If the instrument is provided with an automatic zero-setting or zero-tracking device, it may be in operation during the test, in which case the error at zero point shall be determined according to A.4.2.3.2.

Figure 11

Proposed test sequence for test A.5.3.1 combined with A.5.3.2
(temperature test where the temperature limits are +40 °C / -10 °C)

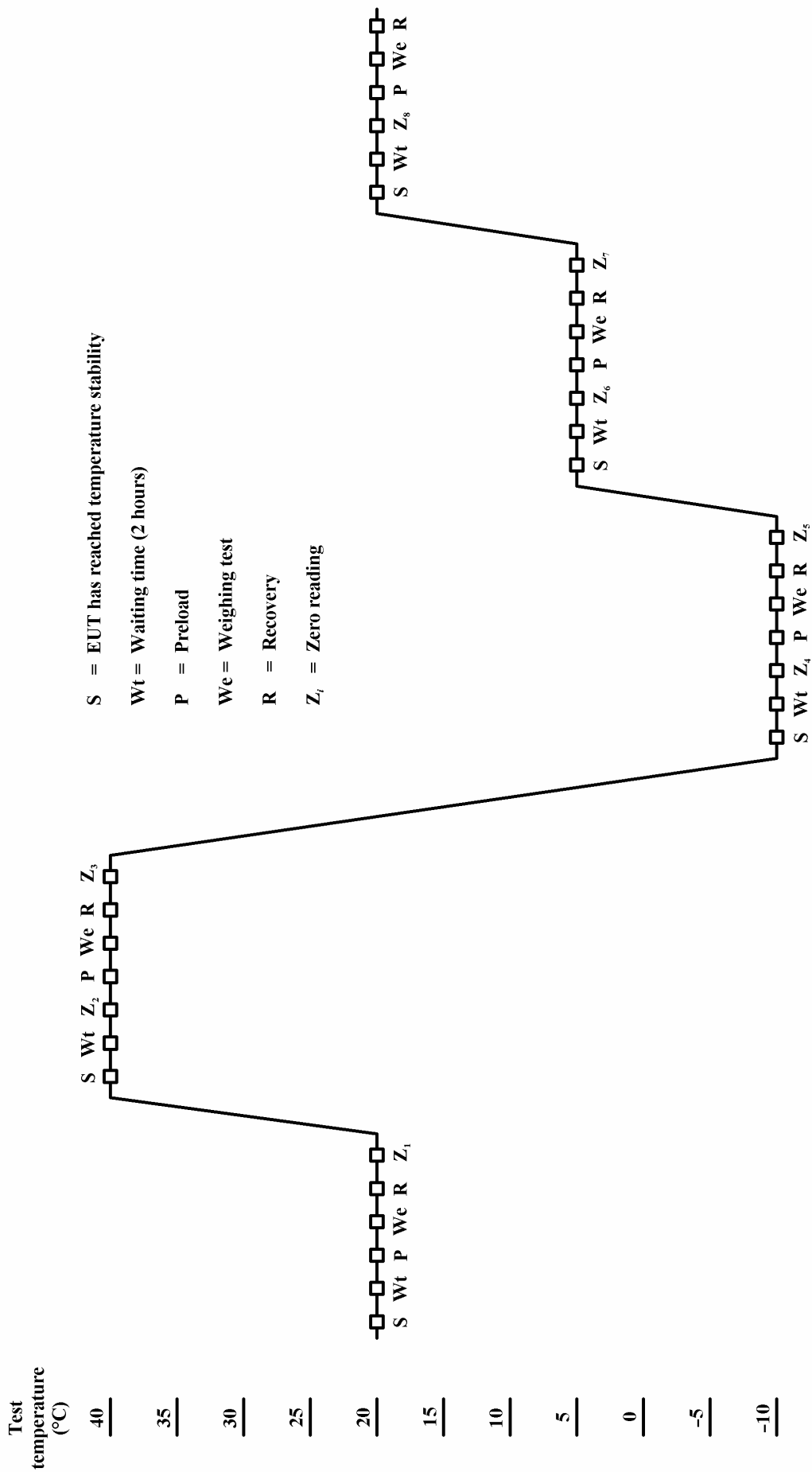

ANNEX B
(Mandatory)

Additional tests for electronic instruments

Preliminary note 1: The tests which are specific to electronic instruments, as described in this Annex, have been taken as far as possible from the work of the International Electrotechnical Commission (IEC) also taking into consideration the latest edition of the OIML International Document D 11 [4].

Preliminary note 2: Although references to current versions of IEC publications have been made, all EMC and other additional tests for electronic instruments should be conducted on the basis of most recent versions valid at the time of testing. This should be mentioned in the Test Report. The objective is to keep pace with future technical developments.

B.1 General requirements for electronic instruments under test

Energize the equipment under test (EUT) for a time period equal to or greater than the warm-up time specified by the manufacturer and maintain the EUT energized for the duration of the test.

Adjust the EUT as closely as practicable to zero prior to each test, and do not readjust it at any time during the test, except to reset it if a significant fault has been indicated. The deviation of the no-load indication due to any test condition shall be recorded, and any load indication shall be corrected accordingly to obtain the weighing result.

The handling of the instrument shall be such that no condensation of water occurs on the instrument.

B.2 Damp heat, steady state

Note: Not applicable to class I instruments or class II instruments where e is less than 1 g.

Test procedure in brief: The test consists of exposure of the EUT to a constant temperature (see A.4.1.2) and a constant relative humidity. The EUT shall be tested with at least five different test loads (or simulated loads):

- at the reference temperature (20 °C or the mean value of the temperature range whenever 20 °C is outside this range) and a relative humidity of 50 % following conditioning;
- at the high temperature of the range specified in 3.9.2 and a relative humidity of 85 %, two days following temperature and humidity stabilization; and
- at the reference temperature and relative humidity of 50 %.

Maximum allowable variations: All functions shall operate as designed.
All indications shall be within maximum permissible errors.

Reference: [8], [10]

B.3 Performance tests for disturbances

Prior to any test, the rounding error shall be set as close as possible to zero.

If there are interfaces on the instrument, an appropriate peripheral device shall be connected to each different type of interface during the tests.

For all tests note the environmental conditions at which they were realized.

Energize the EUT for a time period equal to or greater than the warm-up time specified by the manufacturer and maintain the EUT energized for the duration of the test.

Adjust the EUT as closely as practicable to zero prior to each test, and do not readjust it at any time during the test, except to reset it if a significant fault has been indicated. The deviation of the no-load indication due to any test condition shall be recorded, and any load indication shall be corrected accordingly to obtain the weighing result.

The handling of the instrument shall be such that no condensation of water occurs on the instrument.

Necessary additional or alternative disturbance tests for non-automatic weighing instruments powered from the vehicle battery shall be conducted according to [20], [21], [22] (see also B.3.7).

B.3.1 AC mains voltage dips and short interruptions

Test procedure in brief:

Stabilize the EUT under constant environmental conditions.

A test generator suitable to reduce for a defined period of time the amplitude of one or more half cycles (at zero crossings) of the AC mains voltage shall be used. The test generator shall be adjusted before connecting the EUT. The mains voltage reductions shall be repeated 10 times with an interval of at least 10 seconds.

The test shall be performed with one small test load.

Test severity:

Test	Reduction of amplitude to	Duration/ number of cycles
Voltage dips: Test a	0 %	0.5
Voltage dips: Test b	0 %	1
Voltage dips: Test c	40 %	10
Voltage dips: Test d	70 %	25
Voltage dips: Test e	80 %	250
Short interruption	0 %	250

Maximum allowable variations:

The difference between the weight indication due to the disturbance and the indication without the disturbance shall either not exceed e or the instrument shall detect and react to a significant fault.

Reference:

[4]

B.3.2 Bursts

The test consists in exposing the EUT to specified bursts of voltage spikes for which the repetition frequency of the impulses and peak values of the output voltage on a 50 Ω and a 1 000 Ω load are

defined in the referenced standard. The characteristics of the generator shall be adjusted before connecting the EUT.

Before any test stabilize the EUT under constant environmental conditions.

The test shall be applied separately to:

- power supply lines; and
- I/O circuits and communication lines, if any.

The test shall be performed with one small test load.

Both positive and negative polarity of the bursts shall be applied. The duration of the test shall not be less than one minute for each amplitude and polarity. The injection network on the mains shall contain blocking filters to prevent the burst energy from being dissipated in the mains. For the coupling of the bursts into the input/output and communication lines, a capacitive coupling clamp as defined in the standard shall be used.

Test severity:	Level 2
Amplitude (peak value)	Power supply lines: 1 kV, I/O signal, data and control lines: 0.5 kV.
Maximum allowable variations:	The difference between the weight indication due to the disturbance and the indication without the disturbance shall either not exceed e or the instrument shall detect and react to a significant fault.
Reference:	[14]

B.3.3 Surge

This test is only applicable in those cases where, based on typical situations of installation, the risk of a significant influence of surges can be expected. This is especially relevant in cases of outdoor installations and/or indoor installations connected to long signal lines (lines longer than 30 m or those lines partially or fully installed outside the buildings regardless of their length).

The test is applicable to power lines, communication lines (internet, dial up modem, etc.), and other lines for control, data or signal mentioned above (lines to temperature sensors, gas or liquid flow sensors, etc.).

It is also applicable to DC powered instruments if the power supply comes from DC mains.

The test consists of exposing the EUT to surges for which the rise time, pulse width, peak values of the output voltage/current on high/low impedance load and minimum time interval between two successive pulses are defined in the referenced standard. The characteristics of the generator shall be adjusted before connecting the EUT.

Before any test stabilize the EUT under constant environmental conditions.

The test shall be applied to power supply lines.

On AC mains supply lines at least 3 positive and 3 negative surges shall be applied synchronously with AC supply voltage in angles 0°, 90°, 180° and 270°. On any other kind of power supply, at least three positive and three negative surges shall be applied.

The test shall be performed with one small test load.

Both positive and negative polarity of the surges shall be applied. The duration of the test shall not be less than one minute for each amplitude and polarity. The injection network on the mains shall contain blocking filters to prevent the surge energy being dissipated in the mains.

Test severity:	Level 2
Amplitude (peak value)	Power supply lines: 0.5 kV (line to line) and 1 kV (line to earth)

Maximum allowable variations: The difference between the weight indication due to the disturbance and the indication without the disturbance shall either not exceed e or the instrument shall detect and react to a significant fault.

Reference: [15]

B.3.4 Electrostatic discharge

The test consists in exposing the EUT to specified direct and indirect electrostatic discharges.

An electrostatic discharge generator shall be used which has a performance as defined in the referenced standard. Before starting the tests, the performance of the generator shall be adjusted.

This test includes the paint penetration method, if appropriate.

For direct discharges the air discharge shall be used where the contact discharge method cannot be applied.

Before any test stabilize the EUT under constant environmental conditions.

At least 10 discharges shall be applied. The time interval between successive discharges shall be at least 10 seconds. The test shall be performed with one small test load.

For an EUT not equipped with a ground terminal, the EUT shall be fully discharged between discharges.

Contact discharges shall be applied on conductive surfaces; air discharges shall be applied on non-conductive surfaces.

Direct application: In the contact discharges mode the electrode shall be in contact with the EUT. In the air discharge mode the electrode is approached to the EUT and the discharge occurs by spark.

Indirect application: The discharges are applied in the contact mode to coupling planes mounted in the vicinity of the EUT.

Test severity: Level 3 (see IEC 61000-4-2 [12])
DC voltage up to and including 6 kV for contact discharges and 8 kV for air discharges.

Maximum allowable variations: The difference between the weight indication due to the disturbance and the indication without the disturbance shall either not exceed e or the instrument shall detect and react to a significant fault.

Reference: [12]

B.3.5 Immunity to radiated electromagnetic fields

The test consists of exposing the EUT to specified electromagnetic fields.

Test equipment: See IEC 61000-4-3 [13]

Test set-up: See IEC 61000-4-3 [13]

Test procedure: See IEC 61000-4-3 [13]

Before any test, stabilize the EUT under constant environmental conditions.

The EUT shall be exposed to electromagnetic fields of the strength and character as specified by the severity level.

The test shall be performed with one small test load only.

Test severity: Frequency range: 80 MHz-2 000 MHz

Note: For instruments having no mains or other I/O ports available so that the test according to B.3.6 cannot be applied, the lower limit of the radiation test is 26 MHz.

Field strength: 10 V/m

Modulation: 80 % AM, 1 kHz, sine wave

Maximum allowable variations: The difference between the weight indication due to the disturbance and the indication without the disturbance either shall not exceed e or the instrument shall detect and react to a significant fault.

Reference: [13]

B.3.6 Immunity to conducted radio-frequency fields

The test consists in exposing the EUT to disturbances induced by conducted radio-frequency fields.

Test equipment: See IEC 61000-4-6 [16]

Test set-up: See IEC 61000-4-6 [16]

Test procedure: See IEC 61000-4-6 [16]

Before any test, stabilize the EUT under constant environmental conditions.

The EUT shall be exposed to conducted disturbances of the strength and character as specified by the severity level.

The test shall be performed with one small test load only.

Test severity: Frequency range: 0.15 MHz-80 MHz

RF amplitude (50 Ω): 10 V (emf)

Modulation: 80 % AM, 1 kHz, sine wave

Maximum allowable variations: The difference between the weight indication due to the disturbance and the indication without the disturbance either shall not exceed e or the instrument shall detect and react to a significant fault.

Reference: [16]

B.3.7 Special EMC requirements for instruments powered from a road vehicle power supply

B.3.7.1 Electrical transient conduction along the supply line of external 12 V and 24 V batteries

The test consists in exposing the EUT to conducted transient disturbances along supply lines.

Test equipment: See ISO 7637-2 (2004) [21]

Test set-up: See ISO 7637-2 (2004) [21]

Test procedure: See ISO 7637-2 (2004) [21]

Applicable standard: ISO 7637-2 (2004) [21]

Before any test, stabilize the EUT under constant environmental conditions.

The EUT shall be exposed to conducted disturbances of the strength and character as specified by the severity level.

The test shall be performed with one small test load only.

Test pulses: Test pulses 2a+2b, 3a+3b, 4

Objective of the test:

To verify compliance with the provisions mentioned under “maximum allowable variations” under the following conditions:

- transients due to a sudden interruption of current in a device connected in parallel with the device under test due to the inductance of the wiring harness (pulse 2a);
- transients from DC motors acting as generators after the ignition is switched off (pulse 2b);
- transients on the supply lines, which occur as a result of the switching processes (pulses 3a and 3b);
- voltage reductions caused by energizing the starter-motor circuits of internal combustion engines (pulse 4).

Test severity:

Level IV of ISO 7637-2 (2004) [21]:

Battery voltage	Test pulse	Conducted voltage
12 V	2a	+ 50 V
	2b	+ 10 V
	3a	– 150 V
	3b	+ 100 V
	4	– 7 V
24 V	2a	+ 50 V
	2b	+ 20 V
	3a	– 200 V
	3b	+ 200 V
	4	– 16 V

Maximum allowable variations:

The difference between the weight indication due to the disturbance and the indication without the disturbance either shall not exceed e or the instrument shall detect and react to a significant fault.

Reference:

[21]

B.3.7.2 Electrical transient transmission by capacitive and inductive coupling via lines other than supply lines

The test consists in exposing the EUT to conducted disturbances along lines other than supply lines.

Test equipment: See ISO 7637-3 [22]

Test set-up: See ISO 7637-3 [22]

Test procedure: See ISO 7637-3 [22]

Applicable standard: ISO 7637-3 [22]

Before any test, stabilize the EUT under constant environmental conditions.

The EUT shall be exposed to conducted disturbances of the strength and character as specified by the severity level.

The test shall be performed with one small test load only.

Test severity: According to ISO 7637-3 [22]

Test pulses: Test pulses a and b

Objective of the test: To verify compliance with the provisions mentioned under “maximum allowable variations” under conditions of transients which occur on other lines as a result of the switching processes (pulses a and b)

Test severity: Level IV of ISO 7637-3 [22]

Battery voltage	Test pulse	Conducted voltage
12 V	a	– 60 V
	b	+ 40 V
24 V	a	– 80 V
	b	+ 80 V

Maximum allowable variations: The difference between the weight indication due to the disturbance and the indication without the disturbance either shall not exceed e or the instrument shall detect and react to a significant fault.

Reference: [22]

B.4 Span stability test

Note: Not applicable to class I instruments.

Test procedure in brief: The test consists in observing the variations of the error of the EUT under sufficiently constant ambient conditions (reasonably constant conditions in a normal laboratory environment) at various intervals before, during and after the EUT has been subjected to performance tests. For instruments with an incorporated automatic span adjustment device the device shall be activated during this test before each measurement in order to prove its stability and its intended use.

The performance tests shall include the temperature test and, if applicable, the damp heat test; they shall not include any endurance test; other performance tests in Annexes A and B may be performed.

The EUT shall be disconnected from the mains power (also battery) or power supply device, two times for at least 8 hours during the period of the test. The number of disconnections may be increased if the manufacturer specifies so or at the discretion of the approval authority in the absence of any such specification.

For the conduct of this test the manufacturer’s operating instructions shall be considered.

	<p>The EUT shall be stabilized at sufficiently constant ambient conditions after switch-on for at least 5 hours, but at least 16 hours after the temperature and damp heat tests have been performed.</p>
Test duration:	<p>28 days or the period necessary for the performance tests to be carried out, whichever is shorter.</p>
Time between measurements:	<p>Between ½ day and 10 days, with a fairly even distribution of the measurements over the total duration of the test.</p>
Test load:	<p>Near Max. The same test weights shall be used throughout this test.</p>
Number of measurements:	<p>At least 8.</p>
Test sequence:	<p>Stabilize all factors at sufficiently constant ambient conditions.</p> <p>Adjust the EUT as close to zero as possible.</p> <p>Automatic zero-tracking shall be made inoperative and automatic built-in span adjustment device shall be made operative.</p> <p>Apply the test weight(s) and determine the error.</p> <p>At the first measurement immediately repeat zeroing and loading four times to determine the average value of the error. For the next measurements perform only one, unless either the result is outside the specified tolerance or the range of the five readings of the initial measurement is more than 0.1 <i>e</i>.</p> <p>Record the following data:</p> <ul style="list-style-type: none">a) date and time,b) temperature,c) barometric pressure,d) relative humidity,e) test load,f) indication,g) errors,h) changes in test location, <p>and apply all necessary corrections resulting from variations of temperature, pressure, and other influence factors due to the test load between the various measurements.</p> <p>Allow full recovery of the EUT before any other tests are performed.</p>
Maximum allowable variations:	<p>The variation in the errors of indication shall not exceed half the verification scale interval or half the absolute value of the maximum permissible error on initial verification for the test load applied, whichever is greater, on any of the <i>n</i> measurements.</p> <p>Where the differences of the results indicate a trend more than half the allowable variation specified above, the test shall be continued until the trend comes to rest or reverses itself, or until the error exceeds the maximum allowable variation.</p>

ANNEX C
(Mandatory for separately tested modules)

Testing and certification
of indicators and analog data processing devices
as modules of non-automatic weighing instruments

C.1 Applicable requirements

The use of the term “indicator” in the following, includes any analog data processing devices.

Families of indicators are possible if the requirements under 3.10.4 are observed.

The following requirements apply to indicators:

- 3.1.1 Accuracy classes
- 3.1.2 Verification scale interval
- 3.2 Classification of instruments
- 3.3 Additional requirements for multi-interval instruments
- 3.4 Auxiliary indicating devices
- 3.5 Maximum permissible errors
- 3.9.2 Temperature
- 3.9.3 Power supply
- 3.10 Type evaluation tests and examinations
- 4.1 General construction requirements
 - 4.1.1 Suitability
 - 4.1.2 Security
- 4.2 Indication of weighing results
- 4.3 Analog indicating device
- 4.4 Digital indicating devices
- 4.5 Zero-setting and zero-tracking devices
- 4.6 Tare devices
- 4.7 Preset tare devices
- 4.9 Auxiliary verification devices (removable or fixed)
- 4.10 Selection of weighing ranges on a multiple range instrument
- 4.11 Devices for selection (or switching) between various load receptors and/or load transmitting devices and various load measuring devices
- 4.12 “Plus and minus” comparator instruments
- 4.13 Instruments for direct sales to public
- 4.14 Additional requirements for price-computing instruments for direct sales to the public
- 4.16 Price-labeling instruments
- 5.1 General requirements
- 5.2 Acting upon significant faults
- 5.3 Functional requirements
- 5.4 Performance and span stability tests
- 5.5 Additional requirements for software-controlled electronic devices

Note: Especially for PCs, the category and necessary tests according to Table 11 should be observed.

C.1.1 Accuracy class

The indicator shall have the same accuracy class as the weighing instrument it is intended to be used with. An indicator of class III can also be used in a weighing instrument of class IIII taking into account the requirements of class IIII.

C.1.2 Number of verification scale intervals

The indicator shall have the same or a higher number of verification scale intervals as the weighing instrument with which it is intended to be used.

C.1.3 Temperature range

The indicator shall have the same or a larger temperature range as the weighing instrument with which it is intended to be used.

C.1.4 Range of input signal

The range of the analog output signal of the load cell(s) connected shall be within the range of the input signal for which the indicator is specified.

C.1.5 Minimum input signal per verification scale interval

The minimum input signal per verification scale interval (μV) the indicator is specified for shall be equal or smaller than the analog output signal of the load cell(s) connected divided by the number of scale intervals of the weighing instrument.

C.1.6 Range of load cell impedance

The resulting impedance of the load cell(s) connected to the indicator shall be within the range specified for the indicator.

C.1.7 Maximum cable length

Only indicators employing six-wire technology with remote sensing (of the load cell excitation voltage) shall be used if the load cell cable has to be lengthened or if several load cells are connected by means of a separate load cell junction box. However, the length of the (additional) cable between the load cell or the load cell junction box and the indicator shall not exceed the maximum length the indicator is specified for. The maximum cable length depends on the material and the cross section of the single wire, and thus can also be expressed as the maximum wire resistance, given in units of impedance.

C.2 General principles of testing

A number of tests can be performed with either a load cell or a simulator but both have to fulfill the requirements of A.4.1.7. However the disturbance tests should be performed with a load cell or a weighing platform with load cell being the most realistic case.

Note: For the testing of a family of indicators, in principle, the provisions described in 3.10.4 apply. Special attention has to be paid to the possibly different EMC and temperature behavior of different variants of indicators.

C.2.1 Worst case conditions

In order to limit the number of tests the indicator shall, as far as possible, be tested under conditions which cover the maximum range of applications. This means that most tests shall be performed under worst case conditions.

C.2.1.1 Minimum input signal per verification scale interval, e

The indicator shall be tested at minimum input signal (normally minimum input voltage) per verification scale interval, e , specified by the manufacturer. This is assumed to be the worst case for the performance tests (intrinsic noise covering the load cell output signal) and for the disturbance tests (unfavorable ratio of signal and e.g. high frequency voltage level).

C.2.1.2 Minimum simulated dead load

The simulated dead load shall be the minimum value the manufacturer has specified. A low input signal of the indicator covers the maximum range of problems with regard to linearity and other significant properties. The possibility of a larger zero drift with a larger dead load is regarded as a less significant problem. However, possible problems with the maximum value of the dead load (e.g. saturation of the input amplifier) have to be considered.

C.2.2 Testing at high or low simulated load cell impedance

The disturbance tests (see 5.4.3) shall be performed with a load cell instead of a simulator and with the highest practical value of the impedance (at least 1/3 of the specified highest impedance) for the load cell(s) to be connected as specified by the manufacturer. For the “Immunity to radiated electromagnetic fields” test, the load cell(s) should be placed within the uniform area (IEC 61000-4-3 [13]) inside the anechoic chamber. The load cell cable shall not be decoupled because the load cell is supposed to be an essential part of the weighing instrument and not a peripheral (see also Figure 6 in IEC 61000-4-3 [13] which shows a test set-up for a modular EUT).

The influence tests (see 5.4.3) may either be performed using a load cell or a simulator. However the load cell / simulator shall not be exposed to the influence during the tests (i.e. the simulator is outside the climate chamber). The influence tests shall be performed at the lowest impedance of the load cell(s) to be connected as specified by the applicant.

Table 12 indicates which test has to be performed with the lowest impedance (low) and which with the highest practical value of the impedance (high).

Table 12

R 76-1 clause	Article concerning	Fraction, p_i	Impedance	$\mu\text{V}/e$
A.4.4	Weighing performance	0.3 .. 0.8	low	min
A.4.5	Multiple indicating device			
	Analog	1	low	min
	Digital	0	low	min
A.4.6.1	Weighing accuracy with tare		low	min
A.4.10	Repeatability		low	min/max**
A.5.2	Warm-up time test	0.3 .. 0.8	low	min/max**
A.5.3.1	Temperature (effect on amplification)	0.3 .. 0.8	low	min/max**
A.5.3.2	Temperature (effect on no-load)	0.3 .. 0.8	low	min
A.5.4	Voltage variations	1	low	min
3.9.5	Other influences			
B.2.2	Damp heat steady state	0.3 .. 0.8	low	min/max**
B.3.1	AC mains voltage dips and short interruptions	1	high*	min
B.3.2	Bursts	1	high*	min
B.3.3	Surge (if applicable)	1	high*	min
B.3.4	Electrostatic discharge	1	high*	min
B.3.5	Immunity to radiated electromagnetic fields	1	high*	min
B.3.6	Immunity to conducted radio-frequency fields	1	high*	min
B.3.7	Special EMC requirements for instruments powered from road vehicle power supply	1	high*	min
B.4	Span stability	1	low	min

* Test has to be performed with load cell.

** See C.3.1.1.

The impedance of the load cell referred to in this Annex is the input impedance of the load cell which is the impedance that is connected between the excitation lines.

C.2.3 Peripheral equipment

Peripheral equipment shall be supplied by the applicant to demonstrate correct functioning of the system or sub-system and the non-corruption of weighing results.

When performing disturbance tests, peripheral equipment may be connected to all different interfaces. However, if not all optional peripheral equipment is available or cannot be placed on the test site (especially when having to place them in the uniform area during radiated fields tests), then at least

cables shall be connected to the interfaces. Cable types and lengths shall be as specified in the manufacturer's authorized manual. If cable lengths longer than 3 m are specified, testing with lengths of 3 m is regarded as being sufficient.

C.2.4 Adjustment and performance tests

The adjustment (calibration) shall be performed as described by the manufacturer. Weighing tests shall be performed with at least five different (simulated) loads from zero to the maximum number of verification scale intervals, e , with the minimum input voltage per e (for high sensitive indicators possibly also with the maximum input voltage per e , see C.2.1.1). It is preferable to choose points close to the changeover points of the error limits.

C.2.5 Indication with a scale interval smaller than e

If an indicator has a device for displaying the weight value with a smaller scale interval (not greater than $1/5 \times p_i \times e$, high resolution mode), this device may be used to determine the error. It may also be tested in service mode where the "raw values" (counts) of the analog-to-digital converter are given. If either device is used it should be noted in the Test Report.

Prior to the tests it shall be verified that this indicating mode is suitable for establishing the measuring errors. If the high resolution mode does not fulfill this demand, a load cell, weights and small additional weights shall be used to determine the changeover points with an uncertainty better than $1/5 \times p_i \times e$ (see A.4.4.4).

C.2.6 Load cell simulator

The simulator shall be suitable for the indicator. The simulator shall be calibrated for the used excitation voltage of the indicator (AC excitation voltage also means AC calibration).

C.2.7 Fractions, p_i

The standard fraction is $p_i = 0.5$ of the maximum permissible error of the complete instrument, however, it may vary between 0.3 and 0.8.

The manufacturer shall state the fraction p_i which is then used as a basis for the tests for which a range of p_i is assigned (see Table under C.2.2).

No value for the fraction p_i is given with respect to repeatability. Insufficient repeatability is a typical problem of mechanical instruments with leverworks, knives and pans and other mechanical structures that may cause e.g. a certain friction. It is expected that the indicator will normally not cause a lack in repeatability. In the rare cases it does, this is not a lack of repeatability within the meaning of R 76-1, however, special attention shall be paid to the reasons and the consequences.

C.3 Tests

The relevant parts of the Test Report Format (see C.1) and checklist of R 76-2 shall be used for an indicator. The parts of the R 76-2 checklist which are not relevant are those referring to the following R 76-1 requirements:

- 7.1.5.1
- 3.9.1.1
- 4.17.1
- 4.17.2
- 4.13.10
- F.1
- F.2.4
- F.2.5
- F.2.6

C.3.1 Temperature and performance tests

In principle, the temperature effect on the amplification is tested according to the following procedure:

- Carry out the prescribed adjustment procedure at 20 °C.
- Change the temperature and verify that the measuring points are within the error limits after correction of a zero shift.

This procedure shall be carried out at the highest amplification and the lowest impedance to which the indicator can be adjusted. However, those conditions shall ensure that the measurement can be performed with such an accuracy that it is sufficiently certain that non-linearities found in the error curve are not caused by the test equipment used.

In case this accuracy cannot be reached (e.g. with high sensitive indicators) the procedure has to be carried out twice (C.2.1.1). The first measurement has to be carried out with the lowest amplification, using at least five measuring points. The second measurement is carried out with the highest amplification, using two measuring points, one at the low end and one at the high end of the measuring range. The change in amplification due to temperature is acceptable if a line of the same form found at the first measurement, drawn between the two points and corrected for a zero-shift, is inside the relevant error limits (error envelope).

The temperature effect on no load indication is the influence of temperature variation on the zero expressed in changes of the input signal in μV . The zero drift is calculated with the help of a straight line through the indications at two adjacent temperatures. The zero drift should be less than $p_i \times e / 5 \text{ K}$.

C.3.1.1 Tests with high and low amplification

If the minimum input voltage per verification scale interval is very low, i.e. less than or equal to $1 \mu\text{V}/e$, it may be difficult to find a suitable simulator or load cell to determine the linearity. If the value of the fraction p_i is 0.5 for an indicator with $1 \mu\text{V}/e$ then the maximum permissible error for simulated loads smaller than $500 e$ is $\pm 0.25 \mu\text{V}/e$. The error of the simulator shall not cause an effect exceeding $0.05 \mu\text{V}/e$ or at least the repeatability should be equal to or better than $0.05 \mu\text{V}/e$.

In any case, the following has to be taken into account:

- a) The linearity of the indicator is tested over the complete input range. Example: A typical indicator with a load cell excitation power supply of 12 V has a measuring range of 24 mV. If the indicator is specified for 6000 e the linearity can be tested with $24 \text{ mV}/6000 e = 4 \mu\text{V}/e$.
- b) With the same setup, the temperature effect on the amplification shall be measured, during the static temperature test and during the damp heat steady state test.
- c) After that the indicator is set up with the minimum dead load specified and with the minimum input voltage per verification scale interval, e . Suppose this value is $1 \mu\text{V}/e$, which means that only 25 % of the input range is used.
- d) The indicator shall now be tested with an input voltage close to 0 mV and close to 6 mV. The indication at both input voltages is registered at 20 °C, 40 °C, – 10 °C, 5 °C and 20 °C. The differences between the indication at 6 mV (corrected for the indication at 0 mV) at 20 °C and the corrected indications at the other temperatures are plotted on a graph. The points found are connected to the zero point by means of curves of the same shape form as those found in (a) and (b). The curves drawn shall be within the error envelope for 6 000 e .
- e) During this test the temperature effect on no load indication can also be measured to see if the effect is less than $p_i \times e/5 \text{ K}$.
- f) If the indicator fulfils the above-mentioned requirements it also complies with 3.9.2.1, 3.9.2.2, 3.9.2.3 and it complies with the requirements for the static temperature test and damp heat steady state test.

C.3.2 Tare

The influence of tare on the weighing performance depends exclusively on the linearity of the error curve. The linearity will be determined when the normal weighing performance tests are carried out. If the error curve shows a significant nonlinearity, the error envelope shall be shifted along the curve, to see if the indicator meets the demands for the tare value corresponding with the steepest part of the error curve.

C.3.3 Testing the sense function (with six wire load cell connection only)

C.3.3.1 Scope

Indicators intended for connection of strain gauge load cells employ the 4-wire or the 6-wire principle of the load cell connection. When 4-wire technology is used, lengthening the load cell cable or using a separate load cell junction box with an extra cable is not allowed at all. Indicators using 6-wire technology have a sense input enabling the indicator to compensate variations in load cell excitation voltage due to lengthened cables or changes of cable resistance due to temperature. However, in contrast to the theoretical principle of function, the compensation of variations in load cell excitation voltage is limited due to a limited input resistance of the sense input. This may lead to an influence by variation of cable resistance due to temperature variation and result in a significant shift of the span.

C.3.3.2 Test

The sense function shall be tested under worst case conditions, i.e.:

- the maximum value of the load cell excitation voltage;
- the maximum number of load cells that may be connected (can be simulated); and
- the maximum cable length (can be simulated).

C.3.3.2.1 Simulated maximum number of load cells

The maximum number of load cells can be simulated by putting an extra ohmic shunt resistor on the excitation lines, connected in parallel with the load cell simulator or the load cell respectively.

C.3.3.2.2 Simulated maximum cable length

The maximum cable length can be simulated by putting variable ohmic resistors in all six lines. The resistors shall be set to the maximum cable resistance and thus the maximum cable length (depending on the intended material, e.g. copper or others, and the cross section). However, in most cases it is sufficient to place the resistors only in the excitation lines and the sense lines, since the input impedance of the signal input is extremely high in comparison to that of the sense input. Therefore the signal input current is nearly zero or at least extremely small in comparison to the current on the excitation and sense lines. The input current being near to zero, no significant effect can be expected, since the voltage drop is negligible.

C.3.3.2.3 Readjustment of the indicator

The indicator shall be readjusted after having set the cable simulation resistors.

C.3.3.2.4 Determining the span variation

The span between zero and maximum (simulated) load shall be measured. It is assumed that under worst case conditions a change of resistance due to a temperature change corresponding to the whole temperature range of the instrument may occur. Therefore a variation of the resistance, ΔR_{Temp} , corresponding to the difference between minimum and maximum operating temperatures shall be

simulated. The expected variation of resistance shall be determined according to the following formula:

$$\Delta R_{\text{Temp}} = R_{\text{cable}} \times \alpha \times (T_{\text{max}} - T_{\text{min}})$$

where: R_{cable} = resistance of a single wire, calculated according to the following formula:

$$R_{\text{cable}} = (\rho \times l) / A$$

where: ρ = specific resistance of the material (e.g. copper: $\rho_{\text{copper}} = 0.0175 \Omega \text{ mm}^2 / \text{m}$)

l = length of the cable (in m)

A = cross section of the single wire (in mm^2)

α = temperature coefficient of the cable material in $1/\text{K}$ (e.g. for copper, $\alpha_{\text{copper}} = 0.0039 \text{ 1/K}$)

After having set the variable ohmic resistors to the new value the span between zero and maximum load shall be determined again. Since the variation can be positive or negative both directions shall be tested, e.g. for a class III instrument the variation of simulated cable resistance shall correspond to a variation of temperature by 50 K in both directions, increasing and decreasing temperature (the temperature range being $-10 \text{ }^\circ\text{C}$ to $+40 \text{ }^\circ\text{C}$).

C.3.3.2.5 Limits of span variation

For determining the limits of span variation due to temperature influence on the cable, the results of the temperature tests on the indicator shall be considered. The difference between the maximum span error of the indicator due to temperature and the error limit may be assigned to the effect on the span due to limited compensation by the sense device. However, this effect shall not cause an error of more than one third of the absolute value of the maximum permissible error multiplied by p_i .

$$\Delta \text{span}(\Delta T) \leq p_i \times \text{mpe} - E_{\text{max}}(\Delta T)$$

where: $\Delta \text{span}(\Delta T) \leq \frac{1}{3} p_i \times \text{mpe}_{\text{abs}}$

If the indicator is not able to meet these conditions, the maximum cable resistance and thus the maximum cable length has to be reduced or a larger cross section has to be chosen.

The specific cable length may be given in the form m/mm^2 (depending on the material of the cable, e.g. copper, aluminium).

Figure 12

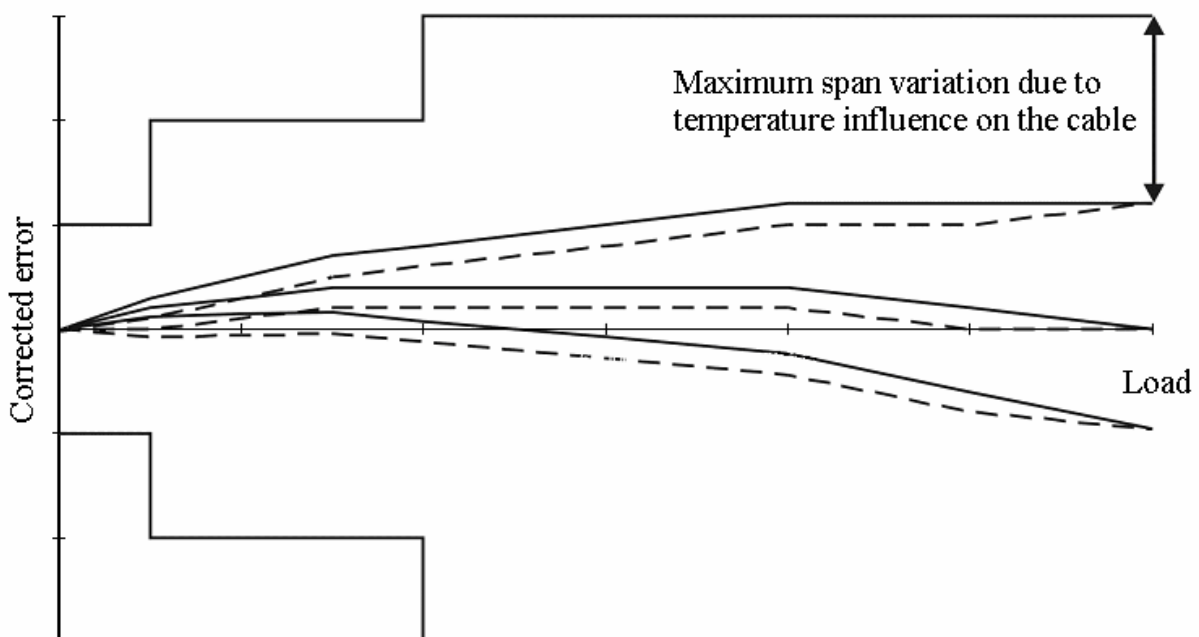

C.3.4 Other influences

Other influences and restraints should be taken into consideration for the complete instrument and not for the modules.

C.4 OIML Certificates

C.4.1 General

The Certificate shall contain common information and data about the Issuing Authority, the manufacturer and the indicator. For the layout the general rules of OIML B 3, Annex A [3] shall be observed as far as applicable.

The following important information about the indicator shall be given under "Identification of the certified module":

- type, accuracy class;
- value of the fractional error, p_i ;
- temperature range;
- maximum number of verification scale intervals;
- minimum input voltage per verification scale interval;
- measuring range; and
- minimum load cell impedance.

C.4.2 Test Report Format

The R 76-2 Test Report Format shall contain detailed information about the indicator. These are technical data, description of the functions, characteristics, features and the checklist from R 76-2. The relevant information is as follows:

Report number:	zzzzz
Type examination of:	Indicator as a module of a non-automatic electromechanical weighing instrument
Issuing authority:	Name, address, person responsible
Manufacturer:	Name, address
Type of module:
Test requirements:	R 76-1, edition xxxx
Summary of the examination:	Separately tested module, $p_i = 0.5$, connected load cell or load cell simulator, connected peripherals, special information if some tests were performed by the manufacturer and why they were accepted, results of the test in brief.
Evaluator:	Name, date, signature
Table of contents:	

This report belongs to OIML Certificate no. R 76/xxxx-yy-zzzz

1 General information concerning the module:

Description of the housing, display, keyboard, plugs and connectors, etc. shall be briefly described and supported by corresponding figures or photos of the indicator.

2 Functions, facilities and devices of the module:

Zero-setting devices, tare devices, weighing ranges, modes of operation, etc. (see clause 4), and facilities of electronic instruments as mentioned in clause 5 shall be listed.

3 Technical data:

In order to check the compatibility of modules when using the modular approach (see 3.10.2 and Annex F) a certain set of data is necessary. This part contains the data of the indicator in the same presentation and units that is needed to check the requirements of Annex F easily.

3.1 Metrological data with regard to the weighing instrument

- Accuracy class
- Maximum number of verification scale intervals, n
- Operating temperature range (°C)
- Value of the fractional error, p_i

3.2 Electrical data

- Power supply voltage (V AC or DC)
- Form (and frequency (Hz)) of the power supply
- Load cell excitation voltage (V AC or DC)
- Minimum signal voltage for dead load (mV)
- Maximum signal voltage for dead load (mV)
- Minimum input voltage per verification scale interval, e (μV)
- Measuring range minimum voltage (mV)
- Measuring range maximum voltage (mV)
- Minimum load cell impedance (Ω)
- Maximum load cell impedance (Ω)

3.3 Sense system

Existing or not existing

3.4 Signal cable

Additional cable between the indicator and the load cell or the load cell junction box respectively (only allowed with indicators using six wire system, i.e. sense system) shall be specified as follows:

- material (copper, aluminium, etc.);
- length (m)
- cross section (mm^2); or
- specific length (m/mm^2) when the material (copper, aluminium etc.) is specified; or
- maximum ohmic resistance per single wire.

4 Documents:

List of documents.

5 Interfaces:

Interface types and numbers for peripheral devices and for other devices.

All interfaces are protective in the sense of 5.3.6.1 in R 76-1.

6 Connectable devices:

Printer, display, etc. For applications not subject to mandatory verification, any peripheral devices may be connected. Examples: D/A converters, PC, etc.

7 Descriptive markings and control marks:

The means to apply the descriptive markings shall be described considering 7.1.4 and 7.1.5 as far as applicable. In addition to the complete instrument the module itself must be clearly identifiable. The places for the descriptive plate and the verification marks shall be described. If applicable the means for sealing and securing the indicator shall be described and shown in figures or photos.

8 Test equipment:

Information concerning the test equipment used for type evaluation of this module and information about calibration of the test equipment. Examples: load cell simulator, temperature chambers, voltmeters, transformers, disturbance test equipment, etc.

9 Remarks on the tests:

Example: In the R 76-2 checklist, the parts related to the complete weighing instrument (“descriptive markings”, “verification marks and sealing” and partially “indicating device”) are not filled in. During the disturbance tests a load cell of the type and a printer of the type was connected.

10 Measuring results:

Forms from R 76-2.

11 Technical requirements:

Checklist from R 76-2.

ANNEX D
(Mandatory for separately tested modules)

**Testing and certification of digital
data processing devices, terminals and digital displays
as modules of non-automatic weighing instruments**

D.1 Applicable requirements

D.1.1 Requirements for digital data processing devices, terminals and digital displays

The following requirements apply to these modules as far as applicable:

- 3.3 Additional requirements for multi-interval instruments
- 3.9.3 Power supply
- 3.9.5 Other influence quantities and restraints
- 3.10 Type evaluation tests and examinations
- 4.1 General construction requirements
- 4.2 Indication of weighing results (*not for digital data processing devices*)
- 4.4 Digital indicating devices (*not for digital data processing devices*)
- 4.5 Zero-setting and zero-tracking devices
- 4.6 Tare devices
- 4.7 Preset-tare devices
- 4.10 Selection of weighing ranges on a multiple range instrument
- 4.11 Devices for selection (or switching) between various load receptors and/or load transmitting devices and various load measuring devices
- 4.13 Instruments for direct sales to the public
- 4.14 Additional requirements for price computing instruments for direct sales to the public
- 4.16 Price-labeling instruments
- 5.1 General requirements
- 5.2 Acting upon significant faults
- 5.3 Functional requirements
- 5.4 Performance and span stability tests
- 5.5 Additional requirements for software-controlled electronic devices
- 8.2.1.2 Descriptive documents

D.1.2 Supplementary requirements

D.1.2.1 Fraction of error limits

Digital data processing devices, terminals and digital displays are purely digital modules. For these modules, the fraction is $p_i = 0.0$ of the maximum permissible error of the complete instrument it is intended to be used with.

D.1.2.2 Accuracy class

Digital data processing devices, terminals and digital displays are purely digital modules. Therefore they can be used in weighing instruments of all accuracy classes. The relevant requirements of the class of weighing instrument they are intended to be used with shall be taken into account.

D.2 General principles of testing

D.2.1 General

Digital data processing devices, terminals and digital displays are purely digital modules. Therefore the:

- design and construction according to the documentation (8.2.1.2);
- functions and indications according to the requirements mentioned in E.1.1; and
- disturbances according to E.3

shall be tested.

However, all indicated values and all functions which are transmitted and/or released via an interface shall be tested to ensure that they are correct and in compliance with this Recommendation.

D.2.2 Simulating devices

For testing these modules a suitable simulating device (e.g. ADC for testing a digital data processing device; weighing module or digital data processing device for testing a terminal or digital display) shall be connected to the input interface of the module so that all functions can be operated and tested.

D.2.3 Displaying devices

For testing a digital data processing device a suitable digital display or terminal shall be connected to display the respective weighing results and to operate all functions of the digital data processing device.

D.2.4 Interface

The requirements of 5.3.6 are applicable to all interfaces.

D.2.5 Peripheral devices

Peripheral devices shall be supplied by the applicant to demonstrate correct functioning of the module and that weighing results cannot inadmissibly be influenced by peripheral devices.

When performing disturbance tests peripheral devices shall be connected to every different interface.

D.3 Tests

For these modules the following tests (according to Annex A and Annex B) shall be performed:

Voltage variations*	A.5.4
AC mains voltage dips and short interruptions**	B.3.1
Bursts**	B.3.2
Surge (if applicable)**	B.3.3
Electrostatic discharge**	B.3.4
Immunity to radiated electromagnetic fields**	B.3.5
Immunity to conducted radio-frequency fields**	B.3.6
Special EMC requirements for instruments powered from road vehicle power supply**	B.3.7

* For the voltage variations test only the legally relevant functions and the easy and unambiguous reading of the primary indications shall be observed.

** Purely digital modules need not be tested for disturbances (B.3) if conformity to the relevant IEC Standards is otherwise established to at least the same level as required in this Recommendation.

The Test Report and the checklist of R 76-2 shall be used also for these modules as far as applicable.

The parts of the checklist of R 76-2 related to “descriptive markings” and “verification marks and sealing” are not relevant and must not be filled in.

D.4 OIML Certificates

D.4.1 General

The Certificate shall contain common information and data about the Issuing Authority, the manufacturer and the module (digital data processing device, terminal or digital display). For the layout, the general rules of OIML B 3 Annex A [3] shall be observed as far as applicable.

D.4.2 Test Report Format

The R 76-2 Test Report shall contain detailed information about the module (digital data processing device, terminal or digital display). These are technical data, description of the functions, characteristics, features and the checklist of R 76-2. The relevant information is as follows:

Report number:	zzzzz
Type examination of a:	Module (digital data processing device, terminal or digital display) for a non-automatic electromechanical weighing instrument.
Issuing authority:	Name, address, person responsible.
Manufacturer:	Name, address.
Type of module:
Test requirements:	R 76-1, edition xxxx
Summary of the examination:	Separately tested module, $p_i = 0.0$, connected devices for simulating the input signal, for displaying the weighing results and to operate the module, connected peripherals, special information as if some tests were performed by the manufacturer and why they were accepted, results of the test in brief.
Evaluator:	Name, date, signature.
Table of contents:	This report belongs to OIML Certificate No. R 76/xxxx-yy-zzzz.
1 General information concerning the type of module:	Short description of the module, interfaces.
2 Functions, facilities and devices of the module:	Zero-setting devices, tare devices, multi-interval function, different weighing ranges, modes of operation, etc.
3 Technical data:	Tare ranges, etc.
4 Documents:	List of documents.
5 Interfaces:	Interface types and numbers, for peripheral devices and for other devices. All interfaces are protective in the sense of 5.3.6.1 of R 76-1.
6 Connectable devices:	Terminal, printer, digital display, etc.. For applications not subject to mandatory verification, any peripheral devices may be connected (examples: D/A converters, PC, etc.).
7 Control marks:	If securing (sealing) is required for the weighing instrument the adjustment elements of this module can be protected by a control mark (adhesive mark or seal).

8 Test equipment:

Information concerning the test equipment used for type evaluation of this module. Information about calibration of the equipment. Examples: voltmeters, transformers, disturbance test equipment, etc.

9 Remarks on the tests:

In the R 76-2 checklist, the parts related to the indicator (“descriptive markings”, “verification marks and sealing” are not filled in. During the disturbance tests a printer of the type ... was connected.

10 Measuring results:

Forms from R 76-2.

11 Technical requirements:

Checklist from R 76-2.

ANNEX E
(Mandatory for separately tested modules)

**Testing and certification of weighing modules
as modules of non-automatic weighing instruments**

E.1 Applicable requirements

E.1.1 Requirements for weighing modules

The following requirements apply to weighing modules:

- 3.1 Principles of classification
- 3.2. Classification of instruments
- 3.3 Additional requirements for multi-interval instruments
- 3.5 Maximum permissible errors
- 3.6 Permissible differences between results
- 3.8 Discrimination
- 3.9 Variations due to influence quantities and time
- 3.10 Type evaluation tests and examinations
- 4.1 General construction requirements
- 4.2 Indication of weighing results
- 4.4 Digital indicating devices
- 4.5 Zero-setting and zero-tracking devices
- 4.6 Tare devices
- 4.7 Preset-tare devices
- 4.10 Selection of weighing ranges on a multiple range instrument
- 4.11 Devices for selection (or switching) between various load receptors and/or load transmitting devices and various load measuring devices
- 4.13 Instruments for direct sales to the public
- 4.14 Additional requirements for price computing instruments for direct sales to the public
- 4.16 Price-labeling instruments
- 5.1 General requirements
- 5.2 Acting upon significant faults
- 5.3 Functional requirements
- 5.4 Performance and span stability tests
- 5.5 Additional requirements for software-controlled electronic devices

E.1.2 Supplementary requirements

E.1.2.1 Fraction of error limits

For a weighing module, the fraction is $p_i = 1.0$ of the maximum permissible error of the complete instrument.

E.1.2.2 Accuracy class

The weighing module shall have the same accuracy class as the weighing instrument it is intended to be used with. A weighing module of class III can also be used in a weighing instrument of class III taking into account the requirements of class III.

E.1.2.3 Number of verification scale intervals

The weighing module shall have at least the same number of verification scale intervals as the weighing instrument it is intended to be used with.

E.1.2.4 Temperature range

The weighing module shall have the same or a wider temperature range as the weighing instrument it is intended to be used with.

E.2 General principles of testing

E.2.1 General

A weighing module shall be tested in the same way as a complete weighing instrument, with the exception of testing the design and construction of the indicating device and control elements. However, all indicated values and all functions which are transmitted and/or released via the interface shall be tested to ensure that they are correct and in compliance with this Recommendation.

E.2.2 Indicating devices

For this test a suitable indicating device or terminal shall be connected to indicate the respective weighing results and to operate all functions of the weighing module.

If the weighing results of the weighing module have a differentiated scale division according to 3.4.1 the indicating device shall indicate this digit.

The indicating device should preferably allow indication to a higher resolution to determine the error, e.g. in a special service mode. If a higher resolution is used it should be noted in the Test Report.

E.2.3 Interface

The requirements of 5.3.6 are applicable to all interfaces.

E.2.4 Peripheral equipment

Peripheral equipment shall be supplied by the applicant to demonstrate correct operation of the system or sub-system and the non-corruption of weighing results.

When performing disturbance tests, peripheral equipment shall be connected to every different interface.

E.3 Tests

The complete testing procedure for non-automatic weighing instruments (according to Annex A and Annex B) shall be performed.

The Test Report and the checklist of R 76-2 shall be used also for weighing modules.

The parts of the checklist of R 76-2 related to “descriptive markings”, “verification marks and sealing” and partially to “indicating device” are not relevant and must not be filled in.

E.4 OIML Certificates

E.4.1 General

The Certificate shall contain common information and data about the Issuing Authority, the manufacturer and the weighing module. For the layout, the general rules of OIML B 3 Annex A [3] shall be observed as far as applicable.

E.4.2 Test Report Format

The R 76-2 Test Report shall contain detailed information about the weighing module. These are technical data, description of the functions, characteristics, features and the checklist of R 76-2. The relevant information is as follows:

Report number:	zzzzz
Type examination of a:	Weighing module for a non-automatic electromechanical weighing instrument.
Issuing authority:	Name, address, person responsible.
Manufacturer:	Name, address.
Type of module:
Test requirements:	R 76-1, edition xxxx.
Summary of the examination:	Separately tested module, $p_i = 1.0$, connected device for indicating the weighing results and to operate the module, connected peripherals, special information as if some tests were performed by the manufacturer and why they were accepted, results of the test in brief.
Evaluator:	Name, date, signature.

Table of contents:

This report belongs to OIML Certificate no. R 76/xxxx-yy-zzzz.

1 General information concerning the type of module:

Description of mechanical structures, load cell, analog data processing device, interfaces.

2 Functions, facilities and devices of the module:

Zero-setting devices, tare devices, multi-interval weighing module, different weighing ranges, modes of operation, etc.

3 Technical data:

Table with accuracy class, $p_i = 1.0$, Max, Min, n , n_i , tare and temperature ranges, etc.

4 Documents:

List of documents.

5 Interfaces:

Interface types and numbers for the indicating and operating device (terminal), for peripheral devices and for other devices.

All interfaces are protective in the sense of 5.3.6.1 of R 76-1.

6 Connectable devices:

Indicating and operating device (terminal) with $p_i = 0.0$, printer, display, etc. For applications not subject to mandatory verification, any peripheral devices may be connected. Examples: D/A converters, PC, etc.

7 Control marks:

If securing (sealing) is required for the weighing instrument, components and adjustment elements of this module can be protected by a control mark (adhesive mark or seal) over the housing screw under the plate of the load receptor. An additional securing is not necessary.

8 Test equipment:

Information concerning the test equipment used for type evaluation of this module. Information about calibration. Examples: standard weights (class), load cell simulator, temperature chambers, voltmeters, transformers, disturbance test equipment, etc.

9 Remarks on the tests:

In the R 76-2 checklist, the parts related to the indicator (“descriptive markings”, “verification marks and sealing” and partially “indicating device”) are not filled in. During the disturbance tests a printer of the type ... was connected.

10 Measuring results:

Forms from R 76-2.

11 Technical requirements:

Checklist from R 76-2.

ANNEX F
(Mandatory for separately tested modules)

Compatibility checking of modules of non-automatic weighing instruments

- Notes:*
- F.1 to F.4:**
Only for analog load cells in conformity with R 60 in combination with indicators in conformity with R 76-1 Annex C.
- F.5:**
Only for digital load cells in combination with indicators, analog or digital data processing units or terminals.
- F.6:**
Examples of compatibility checks.

When using the modular approach, the compatibility check of the weighing instrument and the modules needs certain sets of data. The first three clauses of this Annex describe the data of the weighing instrument, the load cell(s) and the indicator that are needed to check the compatibility requirements.

F.1 Weighing instruments

The following metrological and technical data of the weighing instrument are necessary for the compatibility check:

		Accuracy class of the weighing instrument.
Max	(g, kg, t)	Maximum capacity of weighing instrument according to T.3.1.1 (Max ₁ , Max ₂ , ..., Max in the case of a multi-interval weighing instrument and Max ₁ , Max ₂ , ..., Max _r in the case of a multiple range weighing instrument).
<i>e</i>	(g, kg)	Verification scale interval according to T.3.2.3. (<i>e</i> ₁ , <i>e</i> ₂ , <i>e</i> ₃) (in the case of a multi-interval or multiple range weighing instrument, where <i>e</i> ₁ = <i>e</i> _{min}).
<i>n</i>		Number of verification scale intervals according to T.3.2.5: $n = \text{Max} / e$ (<i>n</i> ₁ , <i>n</i> ₂ , <i>n</i> ₃) (in the case of a multi-interval or multiple range weighing instrument, where <i>n</i> _{<i>i</i>} = Max _{<i>i</i>} / <i>e</i> _{<i>i</i>}).
<i>R</i>		Reduction ratio, e.g. of a lever work according to T.3.3, is the ratio (Force on the load cell) / (Force on the load receptor).
<i>N</i>		Number of load cells
IZSR	(g, kg)	Initial zero setting range, according to T.2.7.2.4: the indication is automatically set to zero when the weighing instrument is switched on, before any weighing.
NUD	(g, kg)	Correction for non-uniform distributed load**.
DL	(g, kg)	Dead load of load receptor: mass of the load receptor itself resting upon the load cells and any additional construction mounted on the load receptor.
T ⁺	(g, kg, t)	Additive tare.
<i>T</i> _{min}	(°C)	Lower limit of temperature range.
<i>T</i> _{max}	(°C)	Upper limit of temperature range.

CH, NH, SH Symbol of humidity test performed.

Connecting system, 6-wire-system:

L (m) Length of connecting cable.

A (mm²) Cross section of wire.

Q Correction factor.

The correction factor, $Q > 1$ considers the possible effects of eccentric loading (non uniform distribution of the load), dead load of the load receptor, initial zero setting range and additive tare in the following form:

$$Q = (\text{Max} + \text{DL} + \text{IZSR} + \text{NUD} + T^+) / \text{Max}$$

** The values for the non uniform distribution of the load generally might be assumed for typical constructions of weighing instruments when no other estimations are presented.

- Weighing instruments (WIs) with lever work and one load cell, or WIs with load receptors which allow only minimal eccentric load application, or WIs with one single point load cell: 0 % of Max
e.g. hopper or funnel hopper with a symmetric arrangement of the load cells, but without shaker for material flow on the load receptor
- Other conventional WIs: 20 % of Max
- Fork lift scales, over head track scales and weighbridges: 50 % of Max
- Multi-platform weighing machine:
 - fixed combination: 50 % of Max_{total}
 - variable selection or combined: 50 % of Max_{single bridge}

F.2 Separately tested load cells

Load cells that have been tested separately according to R 60 may be used without repeated testing if a respective OIML Certificate exists and the requirements in 3.10.2.1, 3.10.2.2, and 3.10.2.3 are met. Only SH and CH tested load cells are allowed under the modular approach (not NH load cells).

F.2.1 Accuracy classes

The accuracy classes including temperature ranges and the evaluation of stability against humidity and creep of load cell(s) (LC) must meet the requirements for the weighing instrument (WI).

Table 13 – Corresponding accuracy classes

	Accuracy				Reference
	I	II	III	III	
WI	I	II	III	III	OIML R 76
LC	A	A*, B	B*, C	C, D	OIML R 60

* if the temperature ranges are sufficient and the evaluation of stability against humidity and creep correspond to the requirement in the lower class.

F.2.2 Fraction of the maximum permissible error

If no value for the load cell is indicated in the OIML Certificate, then $p_{LC} = 0.7$. The fraction may be $0.3 \leq p_{LC} \leq 0.8$, in accordance with 3.10.2.1.

F.2.3 Temperature limits

If no value for the load cell is indicated in the OIML Certificate, then $T_{\min} = -10$ °C and $T_{\max} = 40$ °C. The temperature range may be limited, in accordance with 3.9.2.2.

F.2.4 Maximum capacity of the load cell

The maximum capacity of the load cell shall satisfy the condition:

$$E_{\max} \geq Q \times \text{Max} \times R / N$$

F.2.5 Minimum dead load of the load cell

The minimum load caused by the load receptor must equal or exceed the minimum dead load of a load cell (a lot of load cells have $E_{\min} = 0$):

$$E_{\min} \leq \text{DL} \times R / N$$

F.2.6 Maximum number of load cell intervals

For each load cell the maximum number of load cell intervals, n_{LC} , (see OIML R 60) shall not be less than the number of verification scale intervals, n , of the instrument:

$$n_{\text{LC}} \geq n$$

On a multiple range or multi-interval instrument, this applies to any individual weighing range or partial weighing range:

$$n_{\text{LC}} \geq n_i$$

On a **multi-interval** instrument, the minimum dead load output return, DR (see OIML R 60), shall satisfy the condition:

$$DR \times E / E_{\max} \leq 0.5 \times e_1 \times R / N, \text{ or } DR / E_{\max} \leq 0.5 \times e_1 / \text{Max}$$

Where: $E = \text{Max} \times R / N$ is the partial loading of the load cell when loading the weighing instrument with Max.

Acceptable solution:

Where DR is not known, the condition $n_{\text{LC}} \geq \text{Max} / e_1$ is satisfied.

Furthermore on a **multiple range** instrument where the same load cell(s) is (are) used for more than one range, the minimum dead load output return, DR , of the load cell (see OIML R 60) shall satisfy the condition:

$$DR \times E / E_{\max} \leq e_1 \times R / N, \text{ or } DR / E_{\max} \leq e_1 / \text{Max}$$

Acceptable solution:

Where DR is not known, the condition $n_{\text{LC}} \geq 0.4 \times \text{Max}_r / e_1$ is satisfied.

F.2.7 Minimum load cell verification interval

The minimum load verification interval, v_{\min} , (see OIML R 60) shall not be greater than the verification scale interval, e , multiplied by the reduction ratio, R , of the load transmitting device and divided by the square root of the number, N , of load cells, as applicable:

$$v_{\min} \leq e_1 \times R / \sqrt{N}$$

Note: v_{\min} is measured in mass units. The formula applies to both analog and digital load cells.

On a multiple range instrument where the same load cell(s) is (are) used for more than one range, or a multi-interval instrument, e is to be replaced by e_1 .

F.2.8 Input resistance of a load cell

The input resistance of a load cell, R_{LC} , is limited by the indicator:

$$R_{\text{LC}} / N \text{ has to be within the range for the indicator } R_{\text{Lmin}} \text{ to } R_{\text{Lmax}}$$

F.3 Separately tested indicators and analog data processing devices

Indicators and analog data processing devices that have been tested separately according to Annex C may be used without repeated testing if a respective OIML Certificate exists and the requirements in 3.10.2.1, 3.10.2.2, and 3.10.2.3 are met.

F.3.1 Accuracy class

The accuracy classes including temperature ranges and the evaluation of stability against humidity must meet the requirements for the weighing instrument (WI).

Table 14 – Corresponding accuracy classes

	Accuracy				Reference
WI	I	II	III	III	OIML R 76
IND	I	I*, II	II*, III	III, III	OIML R 76

* if the temperature ranges are sufficient and the evaluation of stability against humidity correspond to the requirement in the lower class.

F.3.2 Fraction of the maximum permissible error

If no value for the indicator is indicated in the OIML Certificate, then $p_{\text{ind}} = 0.5$. The fraction may be $0.3 \leq p_{\text{ind}} \leq 0.8$ in accordance with 3.10.2.1.

F.3.3 Temperature limits

If no value for the load cell is indicated in the OIML Certificate, then $T_{\text{min}} = -10 \text{ °C}$ and $T_{\text{max}} = 40 \text{ °C}$. The temperature range may be limited in accordance with 3.9.2.2.

F.3.4 Maximum number of verification intervals

For each indicator the maximum number of verification intervals, n_{ind} , shall not be less than the number of verification scale intervals, n , of the weighing instrument:

$$n_{\text{ind}} \geq n$$

On a multiple range or multi-interval instrument, this applies to any individual weighing range or partial weighing range:

$$n_{\text{ind}} \geq n_i$$

In case of multi-interval or multiple range applications, these functions must be included in the certified indicator.

F.3.5 Electrical data with regard to the weighing instrument

U_{exc}	(V)	Load cell excitation voltage
U_{min}	(mV)	General minimum input voltage for indicator
Δu_{min}	(μV)	Minimum input voltage per verification scale interval for the indicator

The signal per verification scale interval, Δu , is calculated as follows:

$$\Delta u = \frac{C}{E_{\text{max}}} \times U_{\text{exc}} \times \frac{R}{N} \times e$$

For multiple range or multi-interval WIs, $e = e_1$

U_{MRmin}	(mV)	Measuring range minimum voltage
--------------------	------	---------------------------------

U_{MRmax}	(mV)	Measuring range maximum voltage
R_{Lmin}	(Ω)	Minimum load cell impedance
R_{Lmax}	(Ω)	Maximum load cell impedance
<i>Note:</i>	R_{Lmin} and R_{Lmax} are the limits of the allowed impedance range for the electronic indicator for the actual applied load cell input impedance(s).	

F.3.5.1 Connection cable

Additional cable between the indicator and the load cell or the load cell junction box respectively (only allowed with indicators using six wire system, i.e. **sense system**) must have been specified in the OIML Certificate for the indicator.

The most simple procedure is to specify a value for the ratio of the cable length to the cross section of one wire (m/mm²) for a given material (copper, aluminium, etc.) in the indicator Certificate.

In other cases it must be calculated from length (m), cross section (mm²), the conductor material data and the maximum ohmic resistance (Ω) per single wire.

Note: For cable with different wire cross sections, the connection for the sense-wire is of interest. When using lightning barriers or barriers for explosion-proof applications, the excitation voltage at the load cells must be checked, to prove conditions are met for the minimum input voltage per verification scale interval of the indicator.

F.4 Compatibility checks for modules with analog output

The relevant quantities and characteristics identified which together establish compatibility have been included in the following form. If all conditions are met, the compatibility requirements of R 76 are met. The Tables in which data may be entered allow decisions to be taken easily as to whether or not the conditions are satisfied.

The manufacturer of the weighing instrument can check and prove this compatibility by filling in the form on the following page.

Clause F.6 provides typical examples of filled-in forms for compatibility checks.

Form: Compatibility check

(1) Accuracy class of load cell (LC), indicator (IND) and weighing instrument (WI)

LC	&	IND	equal or better	WI	pass	fail
	&		equal or better		<input type="checkbox"/>	<input type="checkbox"/>

(2) Temp. limits of the weighing instr.(WI) compared with the temp. limits of the load cell (LC) and the indicator (IND) in °C

	LC		IND		WI	pass	fail
T_{min}		&		≤		<input type="checkbox"/>	<input type="checkbox"/>
T_{max}		&		≥		<input type="checkbox"/>	<input type="checkbox"/>

(3) Sum of the squares of the fractions p_i of the max. permissible errors of connecting elements, indicator and load cells

p_{con}^2	+	p_{ind}^2	+	p_{LC}^2	≤ 1	pass	fail
	+		+		≤ 1	<input type="checkbox"/>	<input type="checkbox"/>

(4) Maximum number of verification scale intervals of the indicator and number of scale intervals of the weighing instrument

	n_{ind}	≥	$n_i = Max_i / e_i$	pass	fail
Single range weighing instrument		≥		<input type="checkbox"/>	<input type="checkbox"/>
Multi-interval, or Multiple range WI	$i = 1$	≥		<input type="checkbox"/>	<input type="checkbox"/>
	$i = 2$	≥		<input type="checkbox"/>	<input type="checkbox"/>
	$i = 3$	≥		<input type="checkbox"/>	<input type="checkbox"/>

(5) Maximum capacity of load cells must be compatible with Max of the weighing instrument

Factor, $Q: Q = (Max + DL + IZSR + NUD + T^+) / Max =$

$Q \times Max \times R/N$	≤	E_{max}	pass	fail
	≤		<input type="checkbox"/>	<input type="checkbox"/>

(6a) Maximum number of verification scale intervals of the load cell and number of scale intervals of the weighing instrument

	n_{LC}	≥	$n_i = Max_i / e_i$	pass	fail
Single range weighing instrument		≥		<input type="checkbox"/>	<input type="checkbox"/>
Multi-interval, or Multiple range WI	$i = 1$	≥		<input type="checkbox"/>	<input type="checkbox"/>
	$i = 2$	≥		<input type="checkbox"/>	<input type="checkbox"/>
	$i = 3$	≥		<input type="checkbox"/>	<input type="checkbox"/>

(6b) Minimum dead load output return of the load cell and smallest verification scale interval, e_1 , of a multi-interval WI

$n_{LC} \text{ or } Z = E_{max} / (2 \times DR)$	≥	Max_r / e_1	pass	fail
	≥		<input type="checkbox"/>	<input type="checkbox"/>

(6c) Minimum dead load output return of the load cell and smallest verification scale interval, e_1 , of a multiple range WI

$n_{LC} \text{ or } Z = E_{max} / (2 \times DR)$	≥	$0.4 \times Max_r / e_1$	pass	fail
	≥		<input type="checkbox"/>	<input type="checkbox"/>

(6d) Actual dead load of the load receptor to the minimum dead load of the load cells in kg

$DL \times R/N$	≥	E_{min}	pass	fail
	≥		<input type="checkbox"/>	<input type="checkbox"/>

(7) Verification scale interval of the weighing instrument and minimum load cell scale interval (in kg) must be compatible

$e \times R / \sqrt{N}$	≥	$v_{min} = E_{max} / Y$	pass	fail
	≥		<input type="checkbox"/>	<input type="checkbox"/>

(8) Minimum input voltage in general for the electronic indicator and minimum input voltage per verification scale interval and actual output of the load cells

Minimum input voltage in general for electr. ind. (unloaded WI)	$U = C \times U_{exc} \times R \times DL / (E_{max} \times N)$	≥	U_{min}	pass	fail
		≥		<input type="checkbox"/>	<input type="checkbox"/>
Minimum input voltage per verification scale interval	$\square u = C \times U_{exc} \times R \times e / (E_{max} \times N)$	≥	Δu_{min}	pass	fail
		≥		<input type="checkbox"/>	<input type="checkbox"/>

(9) Allowed impedance range for the electronic indicator and actual load cell impedance in Ω

R_{Lmin}	≤	R_{LC} / N	≤	R_{Lmax}	pass	fail
	≤		≤		<input type="checkbox"/>	<input type="checkbox"/>

(10) Length of extension cable between the load cell(s) and indicator per wire cross section of this cable in m/mm^2

(L/A)	≤	$(L/A)_{max}$	pass	fail
	≤		<input type="checkbox"/>	<input type="checkbox"/>

F.5 Compatibility checks for modules with digital output

For weighing modules and other digital modules or devices (see Figure 1), no special compatibility checks are necessary; testing of the correct operation of one complete instrument is sufficient. If there is no correct data transmission between the modules (and probably between other components/devices) the instrument will not work at all or some functions will fail, e.g. zero-setting or tare.

For digital load cells, the same compatibility check as in F.4 applies, with the exception of conditions (8), (9) and (10) in the form.

F.6 Examples of compatibility checks for modules with analog output

F.6.1 Road vehicle weigher with one measuring range (Example no. 1)

Weighing instrument:

accuracy class	III
maximum capacity	Max = 60 t
verification scale interval	$e = 20$ kg
number of load cells	$N = 4$
without leverwork	$R = 1$
dead load of load receptor	DL = 12 t
initial zero-setting range	IZSR = 10 t
correction for non uniform distributed load	NUD = 30 t
additive tare	$T^+ = 0$
temperature range	- 10 °C to + 40 °C
cable length	$L = 100$ m
cross section of wire	$A = 0.75$ mm ²

Indicator:

accuracy class	III
max. number of verification scale intervals	$n_{\text{ind}} = 3\ 000$
load cell excitation voltage	$U_{\text{exc}} = 12$ V
minimum input voltage	$U_{\text{min}} = 1$ mV
min. input voltage per verification scale interval	$\Delta u_{\text{min}} = 1$ μV
min./max. load cell impedance	30 Ω to 1 000 Ω
temperature range	- 10 °C to + 40 °C
fraction of mpe	$p_{\text{ind}} = 0.5$
cable connection	6 wires
max. value of cable length per wire cross section	$(L/A)_{\text{max}} = 150$ m/mm ²

Load cell(s):

accuracy class	C
maximum capacity	$E_{\text{max}} = 30$ t
minimum dead load	$E_{\text{min}} = 2$ t
rated output ¹	$C = 2$ mV/V
max. number of verification scale intervals	$n_{\text{LC}} = 3\ 000$
ratio $E_{\text{max}} / v_{\text{min}}$	$Y = 6\ 000$
ratio $E_{\text{max}} / (2 \times \text{DR})$	$Z = 3\ 000$

¹ Change of output signal of the load cell related to input voltage after loading with E_{max} , normally in mV/V.

Note: For a more moderate calculation the following relative values are used in R 60:

$$Y = E_{\text{max}} / v_{\text{min}}$$

$$Z = E_{\text{max}} / (2 \times \text{DR})$$

input resistance of one load cell
temperature range
fraction of mpe

$R_{LC} = 350 \Omega$
 $- 10 \text{ }^\circ\text{C to } + 40 \text{ }^\circ\text{C}$
 $p_{LC} = 0.7$

Connecting elements:

fraction of mpe

$p_{con} = 0.5$

Compatibility check (Example no. 1)

(1) Accuracy class of load cell (LC), indicator (IND) and weighing instrument (WI)

LC	&	IND	equal or better	WI	pass	fail
C	&	III	equal or better	III	<input checked="" type="checkbox"/>	<input type="checkbox"/>

(2) Temp. limits of the weighing inst. (WI) compared with the temp. limits of the load cell (LC) and the indicator (IND) in °C

	LC		IND		WI	pass	fail
T_{min}	- 10 °C	&	- 10 °C	≤	- 10 °C	<input checked="" type="checkbox"/>	<input type="checkbox"/>
T_{max}	40 °C	&	40 °C	≥	40 °C	<input checked="" type="checkbox"/>	<input type="checkbox"/>

(3) Sum of the squares of the fractions p_i of the max. permissible errors of connecting elements, indicator and load cells

p_{con}^2	+	p_{ind}^2	+	p_{LC}^2	≤ 1	pass	fail
0.25	+	0.25	+	0.49	≤ 1	<input checked="" type="checkbox"/>	<input type="checkbox"/>

(4) Maximum number of verification scale intervals of the indicator and number of scale intervals of the weighing instrument

	n_{ind}	≥	$n_i = Max_i / e_i$	pass	fail
Single range weighing instrument	3 000	≥	3 000	<input checked="" type="checkbox"/>	<input type="checkbox"/>
Multi-interval, or Multiple range WI	$i = 1$	-	-	<input type="checkbox"/>	<input type="checkbox"/>
	$i = 2$	-	-	<input type="checkbox"/>	<input type="checkbox"/>
	$i = 3$	-	-	<input type="checkbox"/>	<input type="checkbox"/>

(5) Maximum capacity of load cells must be compatible to Max of the weighing instrument

Factor $Q: Q = (Max + DL + IZSR + NUD + T^+) / Max = 1.867$

$Q \times Max \times R/N$	≤	E_{max}	pass	fail
28000 kg	≤	30000 kg	<input checked="" type="checkbox"/>	<input type="checkbox"/>

(6a) Maximum number of verification scale intervals of the load cell and number of scale intervals of the weighing instrument

	n_{LC}	≥	$n_i = Max_i / e_i$	pass	fail
Single range weighing instrument	3 000	≥	3 000	<input checked="" type="checkbox"/>	<input type="checkbox"/>
Multi-interval, or Multiple range WI	$i = 1$	-	-	<input type="checkbox"/>	<input type="checkbox"/>
	$i = 2$	-	-	<input type="checkbox"/>	<input type="checkbox"/>
	$i = 3$	-	-	<input type="checkbox"/>	<input type="checkbox"/>

(6b) Minimum dead load output return of the load cell and smallest verification scale interval, e_1 , of a multi-interval WI

$n_{LC} \text{ or } Z = E_{max} / (2 \times DR)$	≥	Max_r / e_1	pass	fail
-	≥	-	<input type="checkbox"/>	<input type="checkbox"/>

(6c) Minimum dead load output return of the load cell and smallest verification scale interval, e_1 , of a multiple range WI

$n_{LC} \text{ or } Z = E_{max} / (2 \times DR)$	≥	$0.4 \times Max_r / e_1$	pass	fail
-	≥	-	<input type="checkbox"/>	<input type="checkbox"/>

(6d) Actual dead load of the load receptor to the minimum dead load of the load cells in kg

$DL \times R / N$	≥	E_{min}	pass	fail
3 000 kg	≥	2 000 kg	<input checked="" type="checkbox"/>	<input type="checkbox"/>

(7) Verification scale interval of the weighing instrument and minimum load cell scale interval (in kg) must be compatible

$e \times R / \sqrt{N}$	≥	$v_{min} = E_{max} / Y$	pass	fail
10.00 kg	≥	5.00 kg	<input checked="" type="checkbox"/>	<input type="checkbox"/>

(8) Minimum input voltage in general for the electronic indicator and minimum input voltage per verification scale interval and actual output of the load cells

Minimum input voltage in general for electr. ind. (unloaded WI)	$U = C \times U_{exc} \times R \times DL / (E_{max} \times N)$	≥	U_{min}	pass	fail
	2.40 mV	≥	1 mV	<input checked="" type="checkbox"/>	<input type="checkbox"/>
minimum input voltage per verification scale interval	$\square u = C \times U_{exc} \times R \times e / (E_{max} \times N)$	≥	Δu_{min}	pass	fail
	4.00 μV	≥	1.0 μV	<input checked="" type="checkbox"/>	<input type="checkbox"/>

(9) Allowed impedance range for the electronic indicator and actual load cell impedance in Ω

R_{Lmin}	≤	R_{LC} / N	≤	R_{Lmax}	pass	fail
30	≤	87.5	≤	1 000	<input checked="" type="checkbox"/>	<input type="checkbox"/>

(10) Length of extension cable between the load cell(s) and indicator per wire cross section of this cable in m/mm²

(L/A)	≤	$(L/A)_{max}$	pass	fail
133.3	≤	150	<input checked="" type="checkbox"/>	<input type="checkbox"/>

F.6.2 Industrial scale with three measuring ranges (Example no. 2)**Weighing instrument**

accuracy class	III
maximum capacity	Max = 5 000 kg Max ₂ = 2 000 kg Max ₁ = 1 000 kg
verification scale interval	e ₃ = 2 kg e ₂ = 1 kg e ₁ = 0.5 kg
number of load cells	N = 4
without leverwork	R = 1
dead load of load receptor	DL = 250 kg
initial zero setting range	IZSR = 500 kg
correction for non uniform distributed load	NUD = 1 000 kg
additive tare	T ⁺ = 0
temperature range	- 10 °C to + 40 °C
cable length	L = 20 m
cross section of wire	A = 0.75 mm ²

Indicator:

accuracy class	III
max. number of verification scale intervals	n _{ind} = 3 000
load cell excitation voltage	U _{exc} = 10 V
minimum input voltage	U _{min} = 0.5 mV
min. input voltage per verification scale interval	Δu _{min} = 1 μV
min./max. load cell impedance	30 Ω to 1 000 Ω
temperature range	- 10 °C to + 40 °C
fraction of mpe	p _{ind} = 0.5
cable connection	6 wires
max. value of cable length per wire cross section	(L/A) _{max} = 150 m/mm ²

Load cell(s):

accuracy class	C
maximum capacity	E _{max} = 2 000 kg
minimum dead load	E _{min} = 0 t
rated output ²	C = 2 mV/V
max. number of verification scale intervals	n _{LC} = 3000
minimum verification scale interval	v _{min} = 0.2 kg
ratio E _{max} / (2 × DR)	Z = 5 000
input resistance of one load cell	R _{LC} = 350 Ω
temperature range	- 10 °C to + 40 °C
fraction of mpe	p _{LC} = 0.7

Connecting elements:

fraction of mpe	p _{con} = 0.5
-----------------	------------------------

² Change of output signal of the load cell related to input voltage after loading with E_{max}, normally in mV/V.

Note: For a more moderate calculation the following relative values are used in R 60:

$$Y = E_{\max} / v_{\min}$$

$$Z = E_{\max} / (2 \times \text{DR})$$

Compatibility check (Example no. 2)

(1) Accuracy class of load cell (LC), indicator (IND) and weighing instrument (WI)

LC	&	IND	equal or better	WI	pass	fail
C	&	III	equal or better	III	<input checked="" type="checkbox"/>	<input type="checkbox"/>

(2) Temp. limits of the weighing inst. (WI) compared with the temp. limits of the load cell (LC) and the indicator (IND) in °C

	LC		IND		WI	pass	fail
T_{min}	- 10 °C	&	- 10 °C	≤	- 10 °C	<input checked="" type="checkbox"/>	<input type="checkbox"/>
T_{max}	40 °C	&	40 °C	≥	40 °C	<input checked="" type="checkbox"/>	<input type="checkbox"/>

(3) Sum of the squares of the fractions, p_i , of the max. permissible errors of connecting elements, indicator and load cells

p_{con}^2	+	p_{ind}^2	+	p_{LC}^2	≤ 1	pass	fail
0.25	+	0.25	+	0.49	≤ 1	<input checked="" type="checkbox"/>	<input type="checkbox"/>

(4) Maximum number of verification scale intervals of the indicator and number of scale intervals of the weighing instrument

		n_{ind}	≥	$n_i = Max_i / e_i$	pass	fail
Single range weighing instrument		-	≥	-	<input type="checkbox"/>	<input type="checkbox"/>
Multi-interval, or Multiple range WI	$i = 1$	3 000	≥	2 000	<input checked="" type="checkbox"/>	<input type="checkbox"/>
	$i = 2$	3 000	≥	2 000	<input checked="" type="checkbox"/>	<input type="checkbox"/>
	$i = 3$	3 000	≥	2 500	<input checked="" type="checkbox"/>	<input type="checkbox"/>

(5) Maximum capacity of load cells must be compatible to Max of the weighing instrument

Factor $Q: Q = (Max + DL + IZSR + NUD + T^+) / Max =$

1.35

$Q \times Max \times R / N$	≤	E_{max}	pass	fail
1 687.5 kg	≤	2 000 kg	<input checked="" type="checkbox"/>	<input type="checkbox"/>

(6a) Maximum number of verification scale intervals of the load cell and number of scale intervals of the weighing instrument

		n_{LC}	≥	$n_i = Max_i / e_i$	pass	fail
Single range weighing instrument		-	≥	-	<input type="checkbox"/>	<input type="checkbox"/>
Multi-interval or Multiple range WI	$i = 1$	3 000	≥	2 000	<input checked="" type="checkbox"/>	<input type="checkbox"/>
	$i = 2$	3 000	≥	2 000	<input checked="" type="checkbox"/>	<input type="checkbox"/>
	$i = 3$	3 000	≥	2 500	<input checked="" type="checkbox"/>	<input type="checkbox"/>

(6b) Minimum dead load output return of the load cell and smallest verification scale interval, e_1 , of a multi-interval WI

$n_{LC} \text{ or } Z = E_{max} / (2 \times DR)$	≥	Max_r / e_1	pass	fail
-	≥	-	<input type="checkbox"/>	<input type="checkbox"/>

(6c) Minimum dead load output return of the load cell and smallest verification scale interval, e_1 , of a multiple range WI

$n_{LC} \text{ or } Z = E_{max} / (2 \times DR)$	≥	$0.4 \times Max_r / e_1$	pass	fail
5 000	≥	4 000	<input checked="" type="checkbox"/>	<input type="checkbox"/>

(6d) Actual dead load of the load receptor to the minimum dead load of the load cells in kg

$DL \times R / N$	≥	E_{min}	pass	fail
62.5 kg	≥	0 kg	<input checked="" type="checkbox"/>	<input type="checkbox"/>

(7) Verification scale interval of the weighing instrument and minimum load cell scale interval (in kg) must be compatible

$e \times R / \sqrt{N}$	≥	$v_{min} = E_{max} / Y$	pass	fail
0.25 kg	≥	0.2 kg	<input checked="" type="checkbox"/>	<input type="checkbox"/>

(8) Minimum input voltage in general for the electronic indicator and minimum input voltage per verification scale interval and actual output of the load cells

Minimum input voltage in general for electr. ind. (unloaded WI)	$U = C \times U_{exc} \times R \times DL / (E_{max} \times N)$	≥	U_{min}	pass	fail
	0.625 mV	≥	0.5 mV	<input checked="" type="checkbox"/>	<input type="checkbox"/>
Minimum input voltage per verification scale interval	$\square u = C \times U_{exc} \times R \times e / (E_{max} \times N)$	≥	Δu_{min}	pass	fail
	1.25 μV	≥	1 μV	<input checked="" type="checkbox"/>	<input type="checkbox"/>

(9) Allowed impedance range for the electronic indicator and actual load cell impedance in Ω

R_{Lmin}	≤	R_{LC} / N	≤	R_{Lmax}	pass	fail
30	≤	87.5	≤	1 000	<input checked="" type="checkbox"/>	<input type="checkbox"/>

(10) Length of extension cable between the load cell(s) and indicator per wire cross section of this cable in m/mm²

(L/A)	≤	$(L/A)_{max}$	pass	fail
26.67	≤	150.0	<input checked="" type="checkbox"/>	<input type="checkbox"/>

ANNEX G
(Mandatory for software-controlled digital devices and instruments)

Additional examinations and tests
for software-controlled digital devices and instruments

Note: More general examination and test procedures for software-controlled devices and measuring instruments are being developed by OIML TC 5/SC 2.

G.1 Devices and instruments with embedded software (5.5.1)

Review the descriptive documents according to 8.2.1.2 and check whether the manufacturer has described or declared that the software is embedded, i.e. that it is used in a fixed hardware and software environment and cannot be modified or uploaded via any interface or by other means after securing or sealing.

Check whether the securing means are described and provide evidence of an intervention.

Check whether there is a software identification that is clearly assigned to the legally relevant software and the legally relevant functions it performs as described in the documentation submitted by the manufacturer.

Check whether the software identification is easily provided by the instrument.

G.2 Personal computers and other devices with programmable or loadable software (5.5.2)

G.2.1 Software documentation

Check that the manufacturer has supplied software documentation according to 5.5.2.2 (d) containing all relevant information to examine the legally relevant software.

G.2.2 Software protection

**G.2.2.1 Software with closed shell
(no access to the operating system and/or programs possible for the user):**

- Check whether there is a complete set of commands (e.g. function keys or commands via external interfaces) supplied and accompanied by short descriptions.
- Check whether the manufacturer has submitted a written declaration of the completeness of the set of commands.

G.2.2.2 Operating system and / or program(s) accessible for the user:

- Check whether a checksum or equivalent signature is generated over the machine code of the legally relevant software (program module(s) subject to legal control and type-specific parameters).
- Check whether the legally relevant software cannot be started if the code is falsified using a text editor.

G.2.2.3 In addition to the cases in G.2.2.1 or G.2.2.2:

- Check whether all device-specific parameters are sufficiently protected, e.g. by a checksum.
- Check whether there is an audit trail for the protection of the device-specific parameters and a description of the audit trail.
- Perform some practical spot checks to test whether the documented protections and functions work as described.

G.2.3 Software interface(s)

- Check whether the program modules of the legally relevant software are defined and separated from the modules of the associated software by a defined protective software interface.
- Check whether the protective software interface itself is part of the legally relevant software.
- Check whether the functions of the legally relevant software that can be released via the protective software interface are defined and described.
- Check whether the parameters that may be exchanged via the protective software interface are defined and described.
- Check whether the description of the functions and parameters are conclusive and complete.
- Check whether each documented function and parameter does not contradict the requirements of this Recommendation.
- Check whether there are appropriate instructions for the application programmer (e.g. in the software documentation) concerning the protectiveness of the software interface.

G.2.4 Software identification

- Check whether there is an appropriate software identification generated over the program module(s) of the legally relevant software and the type-specific parameters at runtime of the instrument.
- Check whether the software identification is indicated on manual command and can be compared with the reference identification fixed at type approval.
- Check whether all relevant program module(s) and type-specific parameters of the legally relevant software are included in the software identification.
- Check also by some practical spot checks whether the checksums (or other signatures) are generated and work as documented.
- Check whether an effective audit trail exists.

G.3 Data storage devices (5.5.3)

Review the documentation submitted and check whether the manufacturer has foreseen a device - whether incorporated in the instrument or connected externally - that is intended to be used for long-term storage of legally relevant data. If so:

G.3.1 Check whether the software used for data storage is realized on a device with embedded software (G.1) or with programmable/ loadable software (G.2). Apply either G.1 or G.2 to examine the software used for data storage.

G.3.2 Check whether the data are stored and retrieved correctly.

Check whether the storage capacity and the measures to prevent inadmissible data loss are described by the manufacturer and are sufficient.

G.3.3 Check whether the data stored contain all relevant information necessary to reconstruct an earlier weighing (relevant information is: gross or net values and tare values (if applicable, together with a distinction of tare and preset tare), the decimal signs, the units (e.g. kg may be encoded), the identification of the data set, the identification number of the instrument or load receptor if several

instruments or load receptors are connected to the data storage device, and a checksum or other signature of the data set stored.

G.3.4 Check whether the data stored are adequately protected against accidental or intentional changes.

Check whether the data are protected at least with a parity check during transmission to the storage device.

Check whether the data are protected at least with a parity check in the case of a storage device with embedded software (5.5.1).

Check whether the data are protected by an adequate checksum or signature (at least 2 bytes, e.g. a CRC-16 checksum with hidden polynomial) in the case of a storage device with programmable or loadable software (5.5.2).

G.3.5 Check whether the data stored are capable of being identified and displayed, that the identification number(s) is stored for later use and recorded on the official transaction medium, i.e. it is printed, for instance, on the print-out.

G.3.6 Check whether the data used for a transaction are stored automatically, i.e. not depending on the decision of the operating person.

G.3.7 Check whether stored data sets which are to be verified by means of the identification are displayed or printed on a device subject to legal control.

G.4 Test Report Format

The Test Report shall contain all relevant information about the hardware and software configuration of the PC examined and the test results.

BIBLIOGRAPHY

Ref.	Standards and reference documents	Description
[1]	International Vocabulary of Basic and General Terms in Metrology (VIM) (1993)	Vocabulary, prepared by a joint working group consisting of experts appointed by BIPM, IEC, IFCC, ISO, IUPAC, IUPAP and OIML
[2]	International Vocabulary of Terms in Legal Metrology, BIML, Paris (2000)	Vocabulary including only the concepts used in the field of legal metrology. These concepts concern the activities of the legal metrology service, the relevant documents as well as other problems linked with this activity. Also included in this Vocabulary are certain concepts of a general character which have been drawn from the VIM.
[3]	OIML B 3 (2003) OIML Certificate System for Measuring Instruments (formerly OIML P 1)	Gives rules for issuing, registering and using OIML Certificates of conformity
[4]	OIML D 11 (2004) General requirements for electronic measuring instruments	Contains general requirements for electronic measuring instruments
[5]	IEC 60068-1 (1988-6), Appendix B (including Amendment 1, 1992-4) Environmental testing. Part 1: General and guidance	Enumerates a series of environmental tests and appropriate severities, and prescribes various atmospheric conditions for measurements for the ability of specimens to perform under normal conditions of transportation, storage and operational use
[6]	IEC 60068-2-1 (1990-05) with amendments 1 (1993-02) and 2 (1994-06) Environmental testing, Part 2: Tests, Test A: Cold	Concerns cold tests on both non heat dissipating and heat dissipating specimens
[7]	IEC 60068-2-2 (1974-01) with amendments 1 (1993-02) and 2 (1994-05) Environmental testing Part 2: Tests, Test B: Dry heat	Contains test Ba : dry heat for non heat dissipating specimen with sudden change of temperature; test Bb dry heat for non heat dissipating specimen with gradual change of temperature; tests Bc : dry heat for heat dissipating specimen with sudden change of temperature; test Bd dry heat for heat dissipating specimen with gradual change of temperature. The 1987 reprint includes IEC No. 62-2-2A

Ref.	Standards and reference documents	Description
[8]	IEC 60068-2-78 (2001-08) Environmental testing - Part 2-78: Tests - Test Cab: Damp heat, steady state <i>(IEC 60068-2-78 replaces the following withdrawn standards: IEC 60068-2-3, test Ca and IEC 60068-2-56, test Cb)</i>	Provides a test method for determining the suitability of electrotechnical products, components or equipment for transportation, storage and use under conditions of high humidity. The test is primarily intended to permit the observation of the effect of high humidity at constant temperature without condensation on the specimen over a prescribed period. This test provides a number of preferred severities of high temperature, high humidity and test duration. The test can be applied to both heat-dissipating and non-heat dissipating specimens. The test is applicable to small equipment or components as well as large equipment having complex interconnections with test equipment external to the chamber, requiring a set-up time which prevents the use of preheating and the maintenance of specified conditions during the installation period.
[9]	IEC 60068-3-1 (1974-01) + Supplement A (1978-01): Environmental testing Part 3 Background information, Section 1: Cold and dry heat tests	Gives background information for Tests A: Cold (IEC 68-2-1), and Tests B: Dry heat (IEC 68-2-2). Includes appendices on the effect of: chamber size on the surface temperature of a specimen when no forced air circulation is used; airflow on chamber conditions; on surface temperatures of test specimens; wire termination dimensions and material on surface temperature of a component; measurements of temperature, air velocity and emission coefficient. Supplement A gives additional information for cases where temperature stability is not achieved during the test.
[10]	IEC 60068-3-4 (2001-08) Environmental testing - Part 3-4: Supporting documentation and guidance - Damp heat tests	Provides the necessary information to assist in preparing relevant specifications, such as standards for components or equipment, in order to select appropriate tests and test severities for specific products and, in some cases, specific types of application. The object of damp heat tests is to determine the ability of products to withstand the stresses occurring in a high relative humidity environment, with or without condensation, and with special regard to variations of electrical and mechanical characteristics. Damp heat tests may also be utilized to check the resistance of a specimen to some forms of corrosion attack.
[11]	IEC 61000-4-1 (2000-04) Basic EMC Publication Electromagnetic compatibility (EMC) Part 4: Testing and measurement techniques Section 1: Overview of IEC 61000-4 series	Gives applicability assistance to the users and manufacturers of electrical and electronic equipment on EMC standards within the IEC 61000-4 series on testing and measurement techniques. Provides general recommendations concerning the choice of relevant tests.

Ref.	Standards and reference documents	Description
[12]	IEC 61000-4-2 (1995-01) with amendment 1 (1998-01) Basic EMC Publication Electromagnetic compatibility (EMC) Part 4: Testing and measurement techniques Section 2: Electrostatic discharge immunity test. Consolidated Edition: IEC 61000-4-2 (2001-04) Ed. 1.2 This publication is based on IEC 60801-2 (second edition: 1991).	Relates to the immunity requirements and test methods for electrical and electronic equipment subjected to static electricity discharges, from operators directly, and to adjacent objects. Additionally defines ranges of test levels which relate to different environmental and installation conditions and establishes test procedures. The object of this standard is to establish a common and reproducible basis for evaluating the performance of electrical and electronic equipment when subjected to electrostatic discharges. In addition, it includes electrostatic discharges which may occur from personnel to objects near vital equipment.
[13]	IEC 61000-4-3 consolidated Edition 2.1 (2002-09) with amendment 1 (2002-08) Electromagnetic compatibility (EMC) Part 4: Testing and measurement techniques Section 3: Radiated, radio-frequency, electromagnetic field immunity test	Applies to the immunity of electrical and electronic equipment to radiated electromagnetic energy. Establishes test levels and the required test procedures. Establishes a common reference for evaluating the performance of electrical and electronic equipment when subjected to radio-frequency electromagnetic fields.
[14]	IEC 61000-4-4 (2004-07) Electromagnetic compatibility (EMC) Part 4-4: Testing and measurement techniques - Electrical fast transient/burst immunity test	Establishes a common and reproducible reference for evaluating the immunity of electrical and electronic equipment when subjected to electrical fast transient/burst on supply, signal, control and earth ports. The test method documented in this part of IEC 61000-4 describes a consistent method to assess the immunity of an equipment or system against a defined phenomenon. The standard defines: <ul style="list-style-type: none"> – test voltage waveform; – range of test levels; – test equipment; – verification procedures of test equipment; – test set-up; and – test procedure. The standard gives specifications for laboratory and post installation tests.
[15]	IEC 61000-4-5 (2001-04) consolidated edition 1.1 (Including Amendment 1 and Correction 1) Electromagnetic compatibility (EMC) Part 4-5: Testing and measurement techniques - Surge immunity test	Relates to the immunity requirements, test methods, and range of recommended test levels for equipment to unidirectional surges caused by overvoltages from switching and lightning transients. Several test levels are defined which relate to different environment and installation conditions. These requirements are developed for and are applicable to electrical and electronic equipment. Establishes a common reference for evaluating the performance of equipment when subjected to high-energy disturbances on the power and inter-connection lines.

Ref.	Standards and reference documents	Description
[16]	IEC 61000-4-6 (2003-05) with amendment 1 (2004-10) Electromagnetic compatibility (EMC) Part 4: Testing and measurement techniques Section 6: Immunity to conducted disturbances, induced by radio-frequency fields	Relates to the conducted immunity requirements of electrical and electronic equipment to electromagnetic disturbances coming from intended radio-frequency (RF) transmitters in the frequency range 9 kHz - 80 MHz. Equipment not having at least one conducting cable (such as mains supply, signal line or earth connection), which can couple the equipment to the disturbing RF fields is excluded. This standard does not intend to specify the tests to be applied to particular apparatus or systems. Its main aim is to give a general basic reference to all concerned product committees of the IEC. The product committees (or users and manufacturers of equipment) remain responsible for the appropriate choice of the test and the severity level to be applied to their equipment.
[17]	IEC 61000-4-11 (2004-03) Electromagnetic compatibility (EMC) Part 4-11: Testing and measuring techniques - Voltage dips, short interruptions and voltage variations immunity tests	Defines the immunity test methods and range of preferred test levels for electrical and electronic equipment connected to low-voltage power supply networks for voltage dips, short interruptions, and voltage variations. This standard applies to electrical and electronic equipment having a rated input current not exceeding 16 A per phase, for connection to 50 Hz or 60 Hz AC networks. It does not apply to electrical and electronic equipment for connection to 400 Hz AC networks. Tests for these networks will be covered by future IEC standards. The object of this standard is to establish a common reference for evaluating the immunity of electrical and electronic equipment when subjected to voltage dips, short interruptions and voltage variations. It has the status of a Basic EMC Publication in accordance with IEC Guide 107.
[18]	IEC 61000-6-1 (1997-07) Electromagnetic compatibility (EMC) Part 6: Generic standards - Section 1: Immunity for residential, commercial and light-industrial environments	Defines the immunity test requirements in relation to continuous and transient, conducted and radiated disturbances, including electrostatic discharges, for electrical and electronic apparatus intended for use in residential, commercial and light-industrial environment, and for which no dedicated product or product-family standard exists. Immunity requirements in the frequency range 0 kHz - 400 GHz are covered and are specified for each port considered. This standard applies to apparatus intended to be directly connected to a low-voltage public mains network or connected to a dedicated DC source which is intended to interface between the apparatus and the low-voltage public mains network.

Ref.	Standards and reference documents	Description
[19]	IEC 61000-6-2 (1999-01) Electromagnetic compatibility (EMC) Part 6: Generic standards Section 2: Immunity for industrial environments	Applies to electrical and electronic apparatus intended for use in industrial environments, for which no dedicated product or product-family immunity standard exists. Immunity requirements in the frequency range 0 Hz - 400 GHz are covered, in relation to continuous and transient, conducted and radiated disturbances, including electrostatic discharges. Test requirements are specified for each port considered. Apparatus intended to be used in industrial locations are characterized by the existence of one or more of the following: <ul style="list-style-type: none"> - a power network powered by a high or medium voltage power transformer dedicated to the supply of an installation feeding manufacturing or similar plant; - industrial, scientific and medical (ISM) apparatus; - heavy inductive or capacitive loads that are frequently switched; - currents and associated magnetic fields that are high.
[20]	ISO 7637-1 (2002) Road vehicles - Electrical disturbance from conducting and coupling Part 1: Definitions and general considerations	Defines basic terms used in the various parts for electrical disturbance by conduction and coupling. Also gives general information relating to the whole International Standard and common to all parts.
[21]	ISO 7637-2 (2004) Road vehicles - electrical disturbance from conducting and coupling Part 2: Electrical transient conduction along supply lines only	Specifies bench tests for testing the compatibility to conducted electrical transients of equipment installed on passenger cars and light commercial vehicles fitted with a 12 V electrical system or commercial vehicles fitted with a 24 V electrical system. Failure mode severity classification for immunity to transients is also given. It is applicable to these types of road vehicle, independent of the propulsion system (e.g. spark ignition or diesel engine, or electric motor).
[22]	ISO 7637-3 (1995) with correction 1 (1995) Road vehicles - Electrical disturbance by conducting and coupling Part 3: Passenger cars and light commercial vehicles with nominal 12 V supply voltage and commercial vehicles with 24 V supply voltage - Electrical transient transmission by capacitive and inductive coupling via lines other than supply lines	Establishes a common basis for the evaluation of the EMC of electronic instruments, devices and equipment in vehicles against transient transmission by coupling via lines other than supply lines. The test intention is the demonstration of the immunity of the instrument, device or equipment when subjected to coupled fast transient disturbances, such as those caused by switching (switching of inductive loads, relay contact bounce, etc.)
[23]	OIML B 10 (2004) + Amendment 1 (2006) Framework for a Mutual Acceptance Arrangement on OIML Type Evaluations (MAA)	Establishes the rules for a voluntary framework whereby Participants within OIML Member States and Associates within Corresponding Members accept and utilize Test Reports (when validated with an OIML Certificate) for type approval or recognition in their national/regional metrological control programs, and/or for issuing subsequent OIML Certificates.